

PRODUCT CATALOG 2024

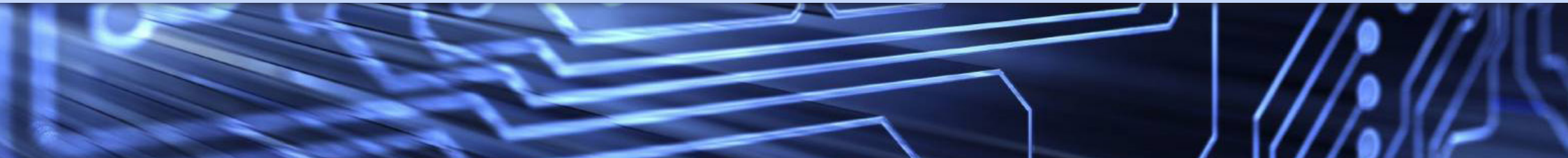

*Worldwide Leader in Legacy Memory*



Alliance Memory is pleased to highlight our new product offerings in DRAM, SRAM, FLASH and eMMC in this new 2024 edition of our Product Selection Guide.

We continue to be the premier legacy memory supplier offering high quality products, minimal die shrinks and long term support.



[www.alliancememory.com](http://www.alliancememory.com)

## Content

Page 3	Synchronous DRAM 3.3V (x4, x8, x16 and x32 )
Page 4	Synchronous DRAM 3.3V Cross Reference
Page 5	DDR1 2.5V DRAM
Page 6	DDR1 2.5V DRAM Cross Reference
Page 7	DDR2 1.8V DRAM / DDR2 1.8V DRAM Cross Reference
Page 8	DDR3 1.5V SDRAM / DDR3L 1.35V SDRAM
Page 9	DDR3/L SDRAM Cross Reference
Page 10	DDR4 SDRAM / DDR4 Cross Reference
Page 11	MOBILE LOW POWER SDRAM / MOBILE LOW POWER SDRAM Cross Reference
Page 12	MOBILE LOW POWER DDR1 / MOBILE LOW POWER DDR1 Cross Reference
Page 13	MOBILE LOW POWER DDR2 / MOBILE LOW POWER DDR2 Cross Reference
Page 14	LPDDR4 / LPDDR4X
Page 15	LPDDR4 Cross Reference / LPDDR4X Cross Reference
Page 16	5V FAST ASYNCHRONOUS SRAM
Page 17	3.3V FAST ASYNCHRONOUS SRAM
Page 18	FAST ASYNCHRONOUS SRAM Cross Reference
Page 22	2.7V- 3.6V LOW POWER SRAMS / 2.7V - 5.5V LOW POWER SRAMS
Page 23	LOW POWER SRAM Cross Reference
Page 27	Parallel 5V NOR Flash
Page 28	Parallel 5V NOR Flash Cross Reference
Page 29	SLC Parallel NAND Flash
Page 30	SLC Parallel NAND Flash Cross Reference
Page 31	Serial NOR Flash
Page 32	Serial NOR Flash Cross Reference
Page 33	Serial SLC NAND Flash / Serial NAND Flash Cross Reference
Page 34	eMMC
Page 35	eMMC Cross Reference
Page 36	pSRAM PSEUDO SRAM / pSRAM Cross Reference
Page 37	ALLIANCE PART NUMBERING SYSTEM - SRAM
Page 38	ALLIANCE PART NUMBERING SYSTEM - DRAM
Page 39	ALLIANCE PART NUMBERING SYSTEM - LPDDR4/x
Page 40	ALLIANCE PART NUMBERING SYSTEM - SLC Parallel NAND Flash
Page 41	ALLIANCE PART NUMBERING SYSTEM - Serial SLC NAND Flash
Page 42	ALLIANCE PART NUMBERING SYSTEM - eMMC
Page 43	ALLIANCE PACKAGING QUANTITIES



# Synchronous DRAM 3.3V ( x4, x8, x16 and x32 )



DENSITY	ORG	VCC	PACKAGE	CLOCK FREQUENCY (MHz)	TEMPERATURE OPTIONS	ALLIANCE
16Mb	1M x 16	3.3V	50pin TSOP II	143/166 MHz	Commercial, Industrial	AS4C1M16S-6/7 TxN
64Mb	4M x 16	3.3V	54pin TSOP II	143/166/200 MHz	Commercial, Industrial, Automotive	AS4C4M16SA-5/6/7 TxN
64Mb	4M x 16	3.3V	54pin TSOP II	166 MHz	Industrial	AS4C4M16SB-6TIN
64Mb	4M x 16	3.3V	54-ball FBGA	143/166 MHz	Commercial, Industrial, Automotive	AS4C4M16SA-6/7 BxN
64Mb	2M x 32	3.3V	90-ball TFBGA	143/166 MHz	Commercial, Industrial	AS4C2M32S-6/7 BxN
64Mb	2M x 32	3.3V	86pin TSOP II	143/166 MHz	Commercial, Industrial	AS4C2M32SA-6/7 TxN
128Mb	8M x 16	3.3V	54pin TSOP II/54-ball FBGA	143/166 MHz	Commercial, Industrial, Automotive	AS4C8M16SA-6/7 TxN/BxN
128Mb	8M x 16	3.3V	54pin TSOP II	166 MHz	Industrial	AS4C8M16SB-6TIN
128Mb	4M x 32	3.3V	90-ball TFBGA	143/166 MHz	Commercial, Industrial	AS4C4M32S-6/7 BxN
128Mb	4M x 32	3.3V	86pin TSOP II	143/166 MHz	Commercial, Industrial	AS4C4M32SA-6/7 TxN
256Mb	16M x 16	3.3V	54pin TSOP II/54-ball FBGA	143/166 MHz	Commercial, Industrial	AS4C16M16SA-6/7 TxN/BxN
256Mb	16M x 16	3.3V	54pin TSOP II/54-ball FBGA	143/166 MHz	Commercial, Industrial	AS4C16M16SB-6/7 TxN/BxN
256Mb	8M x 32	3.3V	86pin TSOP II	143/166 MHz	Commercial, Industrial	AS4C8M32S-6/7 TxN
256Mb	8M x 32	3.3V	90-ball TFBGA	143/166 MHz	Commercial, Industrial	AS4C8M32SA-6/7 BxN
256Mb	32M x 8	3.3V	54pin TSOP II	143/166 MHz	Commercial, Industrial	AS4C32M8SA-6/7 TxN
256Mb	64M x 4	3.3V	54pin TSOP II	143/166 MHz	Commercial, Industrial	AS4C64M4SA-6/7 TxN
512Mb	32M x 16	3.3V	54-ball FBGA	143 MHz	Industrial	AS4C32M16SB-7BIN
512Mb	32M x 16	3.3V	54pin TSOP II	143 MHz/166 MHz	Commercial, Industrial	AS4C32M16SB-6/7 TxN
512Mb	32M x 16	3.3V	54pin TSOP II	143 MHz	Industrial	AS4C32M16SC-7TIN
512Mb	16M x 32	3.3V	86pin TSOP II	143 MHz	Industrial	AS4C16M32SC-7TIN
512Mb	16M x 32	3.3V	90ball TFBGA	166MHz	Commercial, Industrial	AS4C16M32SB-6BxN
512Mb	64M x 8	3.3V	54pin TSOP II	143 MHz	Industrial	AS4C64M8SC-7TIN
512Mb	64M x 8	3.3V	54pin TSOP II	133 MHz	Commercial	AS4C64M8SD-7TCN

\*X= TEMPERATURE GRADE; C = COMMERCIAL ; I = INDUSTRIAL; A = AUTOMOTIVE

# Synchronous DRAM 3.3V Cross Reference



DENSITY	ORG	ALLIANCE	SAMSUNG (EOL)	MICRON	SK HYNIX (EOL)	ISSI	WINBOND	NANYA (EOL)	ELITE (ESMT)	ELPIDA (EOL)
16Mb	1M x 16	AS4C1M16S-6/7TxN	K4S161622E	MT48LC1M16A1	HY57V161610	IS42S16100	W9816G6TH	NT56V1616AOT	M12L16161A-xTG2Q	EDS1616AGTA
64Mb	4M x 16	AS4C4M16SA-5/6/7TxN AS4C4M16SB-6TIN	K4S641632N-UCxx	MT48LC4M16A2P	HY57V641620	IS42S16400 IS45S16400	W9864G6JH	NT56V6620C0T-xxB	M12L64164A-xTG2U	uPD4564163G5-Axx
64Mb	4M x 16	AS4C4M16SA-6/7BxN		MT48LCM16A2B4(F4)	HY5V66D	IS42S16400 IS45S16400	W9864G6JT		M12L64154A-xBG2C	
64Mb	2M x 32	AS4C2M32S-6/7BxN		MT48LC2M32B2B5-X	HY5V62	IS42S32200	W9864G2IB-X			EDS6432AFBH
64Mb	2M x 32	AS4C2M32SA-6/7TxN	K4S643232H-Ucxx	MT48LC2M32B2P-x (EOL)	HY57V643220	IS42S32200	W9864G2J(G,I)H-x		M12L64322A-xTG2U	EDS6432AFTA
128Mb	8M x 16	AS4C8M16SA-6/7TxN AS4C8M16SB-6TIN	K4S281632K-UCxx	MT48LC8M16A2P	HY57V281620	IS42S16800 IS45S16800	W9812G6K(G,I)H	NT55V8M16AT-xxB	M12L128168A-xTG2N	uPD45128163G5-Axx
128Mb	8M x 16	AS4C8M16SA-6/7BxN	K4S281632D-RL75	MT48LC8M16A2B4(F4)	HY5V26	IS42S16800 IS45S16800	W9812G6JB		M12L128168A-xBG2N	
128Mb	4M x 32	AS4C4M32S-6/7BxN		MT48LC4M32B2B5-x	HY5V22	IS42S32400	W9812G21(G)B-x		M12L128324-xBG2E	EDS1232AHBH
128Mb	4M x 32	AS4C4M32SA-6/7TxN		MT48LC4M32B2P-x (EOL)	HY57V283220T	IS42S32400	W9812G2GH			EDS1232AHTA
256Mb	16M x 16	AS4C16M16SA/B-6/7TxN	K4S561632N-UCxx	MT48LC16M16A2P	H57V2562GTR	IS42S16160 IS45S16160	W9825G6K(D,E,J)H	NT55V16M16AT-xxB	M12L2561616A-xTG2A	EDS2516AP(AF,AC) TA-xx
256Mb	16M x 16	AS4C16M16SA/B-6/7BxN	K4S561632D-RL75	MT48LC16M16A2B4	HY5V56	IS42S16160 IS45S16160	W9825G6JB		M12L2561616A-xBG2A	EDS2516EE(JE)BH
256Mb	8M x 32	AS4C8M32S-6/7TxN		MT48LC8M32B2B5-x (EOL)	HY5V52	IS42S32800	W9825G2J(D)B-x			EDS2532EEBH
256Mb	8M x 32	AS4C8M32SA-6/7BxN		MT48LC8M32B2B5-x	HY5V52	IS42S32800	W9825G2J(D)B-x			EDS2532EEBH
256Mb	32M x 8	AS4C32M8SA-6/7TxN		MT48LC32M8A2P		IS42S83200J				
256Mb	64M x 4	AS4C64M4SA-6/7TxN		MT48LC64M4A2P (EOL)		IS42S32800				
512Mb	32M x 16	AS4C32M16SB-7BIN				IS42S16320			M12L5121632A	
512Mb	32M x 16	AS4C32M16SB-6/7TxN	K4S511632M-TC75	MT48LC32M16A2 (EOL)		IS42S16320			M12L5121632A	EDS5116ABTA
512Mb	32M x 16	AS4C32M16SC-7TIN	K4S511632M-TC75	MT48LC32M16A2 (EOL)		IS42S16320			M12L5121632A	EDS5116ABTA
512Mb	16M x 32	AS4C16M32SB-6BxN		MT48LC16M32S2 (EOL)		IS42S32160				
512Mb	16M x 32	AS4C16M32SC-7TIN				IS42S32160				
512Mb	64M x 8	AS4C64M8SC-7TIN		MT48LC64M8A2P-75:C (EOL)		IS42S86400				
512Mb	64M x 8	AS4C64M8SD-7TCN		MT48LC64M8A2P-75:C (EOL)		IS42S86400				

# DDR1 2.5V DRAM

DENSITY	ORG	VCC	PACKAGE	CLOCK FREQUENCY (MHz)	DATA RATE	TEMPERATURE OPTIONS	ALLIANCE
64Mb	4M x 16	2.5V	66pin TSOP II	200 MHz	400 Mbps	Commercial, Industrial, Automotive	AS4C4M16D1A-5TxN
64Mb	2M x 32	2.5V	144-ball FBGA	200 MHz	400 Mbps	Commercial, Industrial	AS4C2M32D1A-5BxN
128Mb	8M x 16	2.5V	66pin TSOP II	200 MHz	400 Mbps	Commercial, Industrial	AS4C8M16D1A-5TxN
128Mb	8M x 16	2.5V	60-ball FBGA	200 MHz	400 Mbps	Commercial, Industrial	AS4C8M16D1-5BxN
128Mb	4M x 32	2.5V	144-ball FBGA	200 MHz	400 Mbps	Commercial, Industrial	AS4C4M32D1A-5BxN
256Mb	16M x 16	2.5V	60-ball FBGA	200 MHz	400 Mbps	Commercial, Industrial, Automotive	AS4C16M16D1-5BxN
256Mb	16M x 16	2.5V	66pin TSOP II	200 MHz	400 Mbps	Commercial, Industrial	AS4C16M16D1A-5TxN
512Mb	32M x 16	2.5V	66pin TSOP II	200 MHz	400 Mbps	Commercial, Industrial, Automotive	AS4C32M16D1A-5TxN
512Mb	32M x 16	2.5V	60-ball FBGA	200 MHz	400 Mbps	Commercial, Industrial, Automotive	AS4C32M16D1-5BxN
512Mb	32M x 16	2.5V	66pin TSOP II	200 MHz	400 Mbps	Commercial, Industrial	AS4C32M16D1-5TxN
512Mb	64M x 8	2.5V	66pin TSOP II 60-ball FBGA	200 MHz	400 Mbps	Commercial, Industrial	AS4C64M8D1-5TxN AS4C64M8D1-5BxN
1Gb	64M x 16	2.5V	66pin TSOP II	166 MHz	333Mbps	Commercial, Industrial	AS4C64M16D1-6TxN
1Gb	64M x 16	2.5V	60-ball FBGA	166 MHz	333Mbps	Industrial	AS4C64M16D1A-6BIN

\* X= TEMPERATURE GRADE; C = COMMERCIAL ; I = INDUSTRIAL; A = AUTOMOTIVE

# DDR1 2.5V DRAM Cross Reference

DENSITY	ALLIANCE	SAMSUNG (EOL)	MICRON	ISSI	HYNIX - ALL EOL	WINBOND	NANYA	ELITE (ESMT)	ELPIDA
64Mb	AS4C4M16D1A-5TxN	K4H641638N	MT46V4M16TG (EOL)	IS43R16400B		W9464G6K(I,J)H		M13S64164A-5TG2Y	(EOL)
64Mb	AS4C2M32D1A-5BxN								
128Mb	AS4C8M16D1-5BxN	K4H281638D		IS43R16800E-5BL		W9412G6JB		M13S128168A-5BG2N	EDD1216A
128Mb	AS4C8M16D1A-5TxN	K4H281638D	MT46V8M16 (EOL)	IS43R16800E-5TL	HY5DU1281622	W9412G6K(I,J)H		M13S128168A-5TG2N	EDD1216A
128Mb	AS4C4M32D1A-5BxN		MT46V4M32FK (EOL)	IS43R32400E-5BL		W9412GIB		M13S128324A-5BG2M	EDD1232A
256Mb	AS4C32M8D1-5TxN	K4H560838N	MT46V32M8P (EOL)	IS43R83200	HY5DU56822		NT5DS32M8ES		EDD2508A
256Mb	AS4C16M16D1-5BxN	K4H561638D	MT46V16M16CY-5B	IS43R16160 IS46R16160	HY5DU561622	W9425G6JB		M13S2561616A-xBG2A	
256Mb	AS4C16M16D1A-5TxN	KH561638D	MT46V16M16P	IS43R16160	HY5DU561622	W945G6K(D,E,J)H		M13S2561616A-xTG2A	EDD2516A
512Mb	AS4C32M16D1-5BxN	K4H511638J	MT46V32M16CY	IS43R16320 IS46R16320	HY5DU121622				EDD5116
512Mb	AS4C32M16D1A-5TxN	K4H511638J	MT46V32M16P	IS43R16320 IS46R16320	HY5DU121622		NT5DS32M16ES	M13S5121632A-5TG2S	EDD5116A
512Mb	AS4C64M8D1-5TxN	K4H510838J	MT46V64M8P	IS43R86400	HY5DU12822		NT5DS64M8ES		EDD5108A
512Mb	AS4C64M8D1-5BxN	K4H510838J	MT46V64M8CY(BN)	IS43R86400	HY5DU12822				
1Gb	AS4C64M16D1-6TxN		MT46V64M16P (EOL)						
1Gb	AS4C64M16D1A-6BIN								

# DDR2 1.8V DRAM

DENSITY	ORG	VCC	PACKAGE	CLOCK FREQUENCY (MHz)	DATA RATE	TEMPERATURE OPTIONS	ALLIANCE
256Mb	16M x 16	1.8V	84-ball FBGA	400 MHz	800 Mbps	Commercial, Industrial	AS4C16M16D2-25BxN
512Mb	32M x 16	1.8V	84-ball FBGA	400 MHz	800Mbps	Commercial, Industrial, Automotive	AS4C32M16D2A/C-25BxN
512Mb	64M x 8	1.8V	60-ball FBGA	400 MHz	800 Mbps	Commercial, Industrial, Automotive	AS4C64M8D2-25BxN
1Gb	64M x 16	1.8V	84-ball FBGA	400 MHz	800Mbps	Commercial, Industrial, Automotive	AS4C64M16D2A-25BxN
1Gb	64M x 16	1.8V	84-ball FBGA	400 MHz	800 Mbps	Commercial	AS4C64M16D2B-25BCN
1Gb	128M x 8	1.8V	60-ball FBGA	400 MHz	800Mbps	Commercial, Industrial	AS4C128M8D2A-25BxN
2Gb	128M x 16	1.8V	84-ball FBGA	400 MHz	800 Mbps	Commercial, Industrial	AS4C128M16D2-25BxN
2Gb	128M x 16	1.8V	84-ball FBGA	400 MHz	800Mbps	Commercial, Industrial	AS4C128M16D2A-25BxN
2Gb	256M x 8	1.8V	60-ball FBGA	400 MHz	800 Mbps	Commercial	AS4C256M8D2A-25BCN

\*X= TEMPERATURE GRADE; C = COMMERCIAL ; I = INDUSTRIAL; A = AUTOMOTIVE

## DDR2 1.8V DRAM Cross Reference

DENSITY	ALLIANCE	SAMSUNG (EOL)	MICRON	ISSI	WINBOND	NANYA	ELITE (ESMT)	HYNIX (EOL)
256Mb	AS4C16M16D2-25BxN	K4T56163Q	MT47H16M16BG	IS43DR16160	W9725G6K(J)B	NT5TU16M16BG	M14D2561616A-2.5BG	HY5PS561621
512Mb	AS4C32M16D2A/C-25BxN	K4T51163Q	MT47H32M16HR(NF)-25E	IS43DR16320 IS46DR16320	W9751G6K(J)B	NT5TU32M16GG	M14D5121632A-2.5BG	HY5PS121621
512Mb	AS4C64M8D2-25BxN	K4T51083Q	MT47H64M8CF(SH)-25E	IS43DR86400 IS46DR86400	W9751G8K(J)B	NT5TU64M8EE		H5PS5182KFR
1Gb	AS4C64M16D2A-25BxN	K4T1G164Q	MT47H64M16HR(NF)-25E	IS43DR16640 IS46DR16640	W971GG6JB	NT5TU64M16HG	M14D1G1664A-2.5BG	H5PS1G63
1Gb	AS4C64M16D2B-25BCN	K4T1G164Q	MT47H64M16HR(NF)-25E	IS43DR16640	W971GG6JB	NT5TU64M16HG	M14D1G1664A-2.5BG	H5PS1G63
1Gb	AS4C128M8D2A-25BxN	K4T1G084Q	MT47H128M8SH-25E	IS43DR81280	W971GG8JB	NT5TU128M8HE	M14D1G8128A	H5PS1G83
2Gb	AS4C128M16D2-25BxN		MT47H128M16RT-25E	IS43DR16128	W972GG6JB			
2Gb	AS4C128M16D2A-25BxN		MT47H128M16RT-25E	IS43DR16128 IS46DR16128	W972GG6JB			
2Gb	AS4C256M8D2A-25BCN		MT47H256M8EB-25E	IS43DR82560	W972GG8JB			

# DDR3 1.5V SDRAM

DENSITY	ORG	VCC	PACKAGE	CLOCK FREQUENCY	DATA RATE	TEMPERATURE OPTIONS	ALLIANCE
512Mb	32M x 16	1.5V	96-ball FBGA	800 MHz	1600 Mbps	Commercial, Industrial	AS4C32M16D3-12BxN
512Mb	64M x 8	1.5V	78-ball FBGA	800 MHz	1600 Mbps	Commercial, Industrial	AS4C64M8D3-12BxN
1Gb	64M x 16	1.5V	96-ball FBGA	800 MHz	1600 Mbps	Commercial, Industrial, Automotive	AS4C64M16D3B-12BxN
1Gb	128M x 8	1.5V	78-ball FBGA	800 MHz	1600 Mbps	Commercial, Industrial, Automotive	AS4C128M8D3B-12BxN
2Gb	128M x 16	1.5V	96-ball FBGA	1066 MHz	2133 Mbps	Commercial	AS4C128M16D3C-93BCN
4Gb	256M x 16	1.5V	96-ball FBGA	800 MHz 933 MHz 1066 MHz	1600 Mbps 1866 Mbps 2133 Mbps	Commercial, Industrial	AS4C256M16D3C-12BxN AS4C256M16D3C-10BxN AS4C256M16D3C-93BxN

\* X= TEMPERATURE GRADE; C = COMMERCIAL ; I = INDUSTRIAL ; A = AUTOMOTIVE

# DDR3L 1.35V SDRAM

DENSITY	ORG	VCC	PACKAGE	CLOCK FREQUENCY	DATA RATE	TEMPERATURE OPTIONS	ALLIANCE
512Mb	32M x 16	1.35V	96-ball FBGA	800 MHz	1600 Mbps	Commercial, Industrial	AS4C32M16D3L-12BxN
512Mb	64M x 8	1.35V	78-ball FBGA	800 MHz	1600 Mbps	Commercial, Industrial	AS4C64M8D3L-12BxN
1Gb	64M x 16	1.35V	96-ball FBGA	800 MHz	1600 Mbps	Commercial, Industrial, Automotive	AS4C64M16D3LB-12BxN AS4C64M16D3LC-12BxN
1Gb	128M x 8	1.35V	78-ball FBGA	800 MHz	1600 Mbps	Commercial, Industrial, Automotive	AS4C128M8D3LB-12BxN AS4C128M8D3LC-12BxN
2Gb	128M x 16	1.35V	96-ball FBGA	800 MHz	1600 Mbps	Commercial, Industrial, Automotive	AS4C128M16D3LC-12BxN
2Gb	256M x 8	1.35V	78-ball FBGA	800 MHz	1600 Mbps	Commercial, Industrial, Automotive	AS4C256M8D3LC-12BxN
4Gb	256M x 16	1.35V	96-ball FBGA	800 MHz 933 MHz	1600 Mbps 1866 Mbps	Commercial, Industrial, Automotive	AS4C256M16D3LC-12BxN AS4C256M16D3LC-10BxN
4Gb	512M x 8	1.35V	78-ball FBGA	800 MHz 933 MHz	1600 Mbps 1866 Mbps	Commercial, Industrial, Automotive	AS4C512M8D3LC-12BxN AS4C512M8D3LC-10BAN
8Gb	512M x 16	1.35V	96-ball FBGA	933 MHz	1866 Mbps	Commercial, Industrial, Automotive	AS4C512M16D3LA-10BxN
8Gb	512M x 16	1.35V	96-ball FBGA	800 MHz	1600 Mbps	Commercial, Industrial	AS4C512M16D3LB-12BxN
8Gb	512M x 16	1.35V	96-ball FBGA	800 MHz 933 MHz	1600 Mbps 1866 Mbps	Commercial, Industrial	AS4C512M16D3LC-12BxN AS4C512M16D3LC-10BxN
8Gb	1G x 8	1.35V	78-ball FBGA	933 MHz	1866 Mbps	Commercial, Industrial, Automotive	AS4C1G8D3LA-10BxN

\* X= TEMPERATURE GRADE; C = COMMERCIAL ; I = INDUSTRIAL ; A = AUTOMOTIVE



# DDR3/L SDRAM Cross Reference

DENSITY	ALLIANCE	MICRON	SAMSUNG(EOL)	ISSI	HYNIX	WINBOND	ELITE (ESMT)	ELPIDA	NANYA
512Mb	AS4C32M16D3-12BxN					W6351G6KB-x	M15T5121632A	EDJ5316BASE	
512Mb	AS4C64M8D3-12BxN							EDJ5308BASE	
512Mb	AS4C32M16D3L-12BxN						M15T5121632A	EDJ5316BASE	
512Mb	AS4C64M8D3L-12BxN							EDJ5308BASE	
1Gb	AS4C64M16D3B-12BxN	MT41J64M16JT(TW)-125 (EOL)	K4B1G1646E(G)	IS43TR16640 IS46TR16640	H5TQ1G63D	W631GG6KB-x	M15F1G1664A	EDJ1116DJ(BA) BG	NT5CB64M16F(G)P
1Gb	AS4C64M16D3LB/C-12BxN	MT41K64M16JT(TW)-125	K4B1G1646E(G)	IS43TR16640xL IS46TR16640xL	H5TC1G63EFR (EOL)	W631GU6KB-x	M15T1G1664A-(2C)	EDJ1116EJBG	NT5CC64M16F(G)P-DI
1Gb	AS4C128M8D3B-12BxN	MT41J128M8JP(DA)-125	K4B1G0846E(F,G)	IS43TR81280 IS46TR81280	H5TQ1G83	W631GG8KB-x	M15T1G8128A	EDJ1108DJ(BA) BG	NT5CB128M8F(G)N-DI
1Gb	AS4C128M8D3LB/C-12BxN	MT41K128M8JP(DA)-125	K4B1G0846G-BY	IS43TR81280xL IS46TR81280xL	H5TC1G83EFR (EOL)	W631GU8KB-x	M15T1G8128A	EDJ1108EJBG	NT5CC128M8F(G)N-DI
2Gb	AS4C128M16D3C-93BCN	MT41J128M16JT(TW)-125	K4B2G1646E-B	IS43TR16128	H5TQ2G63	W632GG6KB-x	M15F2G16128A	EDJ2116DEBG	NT5CB128M16I(F)P-DI
2Gb	AS4C128M16D3LC-12BxN	MT41K128M16JT-125	K4B2G1646Q-B	IS43TR16128xL IS46TR16128xL	H5TC2G63	W632GU6KB-x	M15F2G16128A	EDJ2116EEBG	NT5CC128M16I(F)P-DI
2Gb	AS4C256M8D3LC-12BxN	MT41K256M8DA-125	K4B2G0846Q-BCK	IS43TR82560xL IS46TR82560xL	H5TQ2G83FFR-x	W632GG8KB-x	M15T2G8256A	EDJ2108DEBG	NT5CB256M8IN-FL
4Gb	AS4C256M16D3C-93BCN AS4C256M16D3C-10BxN AS4C256M16D3C-12BxN	MT41J256M16HA-107 MT41J256M16HA-125	K4B4G1646B(D)	IS43TR16256	H5TQ4G63	W634GG6MB/ NB	M15F4G16256A	EDJ4216BFBG (BASE)	NT5CB256M16C(D,E) P-DI
4Gb	AS4C256M16D3LC-10BxN AS4C256M16D3LC-12BxN	MT41K256M16HA-107/125 MT41K256M16TW-107/125	K4B4G1646E(Q)	IS43TR16256xL IS46TR16256xL	H5TC4G63	W634GU6MB/ NB	M15T4G16256A	EDJ4216EFBG	NT5CC256M16C(D,E) P-DI
4Gb	AS4C512M8D3LC-10BAN AS4C512M8D3LC-12BxN	MT41K512M8DA-125	K4B4G0846B(C,D)	IS43TR85120xL IS46TR85120xL	H5TC4G83	W634GU8MB/ NB	M15T4G8512A	EDJ4208EFBG	NT5CC512M8C(D,E) N-DI
8Gb	AS4C512M16D3LA-10BxN	MT41K512M16VRN-107 MT41K512M16VRP-107 MT41K512M16HA-125 (EOL)	K4B8G1646x	IS43TR16512	H5TC8G63CMR	W638GU6QB	M15T8G16512A-DE		NT5CC512T16EH-DI/A/H NT5CC512T16EH-EK/A/H
8Gb	AS4C512M16D3LB-12BxN	MT41K512M16HA-125 (EOL)	K4B8G1646x	IS43TR16512	H5TC8G63CMR	W638GU6QB	M15T8G16512A-BD		NT5CC512T16EH-DI/A/H
8Gb	AS4C512M16D3LC-10BxN AS4C512M16D3LC-12BxN	MT41K512M16VRN-107 MT41K512M16VRP-107 MT41K512M16HA-125 (EOL)	K4B8G1646x	IS43TR16512	H5TC8G63CMR	W638GU6QB	M15T8G16512A-BD M15T8G16512A-DE		NT5CC512T16EH-DI/A/H NT5CC512T16EH-EK/A/H
8Gb	AS4C1G8D3LA-10BxN	MT41K1G8SN-107/125:E	K4B8G0846x	IS43TR81024	H5TC8G83BMR				
8Gb	MT41K512M16HA-125	MT41K512M16HA-125	K4B8G1646x	IS43TR16512	H5TC8G63CMR	W638GU6QB	M15T8G16512A-BD		NT5CC512T16EH-DI/A/H

# DDR4 SDRAM

DENSITY	ORG	VCC	PACKAGES	CLOCK FREQUENCY	DATA RATE	TEMPERATURE OPTIONS	ALLIANCE
4Gb	256M x 16	1.2V	96-ball FBGA (7.5x13.5mm)	1333 MHz 1200 MHz	666 Mbps 2400 Mbps	Commercial, Industrial	AS4C256M16D4-75BxN AS4C256M16D4-83BxN
4Gb	512M x 8	1.2V	78-ball FBGA (7.5x10.6mm)	1333 MHz 1200 MHz	2666 Mbps 2400 Mbps	Commercial, Industrial	AS4C512M8D4-75BxN AS4C512M8D4-83BxN
4Gb	256M x 16	1.2V	96-ball FBGA (7.5x13mm)	1600 MHz 1333 MHz	3200 Mbps 2666 Mbps	Commercial, Industrial	AS4C256M16D4A-62BxN AS4C256M16D4A-75BxN
4Gb	512M x 8	1.2V	78-ball FBGA (7.5x11mm)	1333 MHz	2666 Mbps	Commercial, Industrial	AS4C512M8D4A-75BxN
8Gb	512M x 16	1.2V	96-ball FBGA (7.5x13mm)	1333 MHz	2666 Mbps	Commercial, Industrial	AS4C512M16D4-75BxN
8Gb	512M x 16	1.2V	96-ball FBGA (7.5x13mm)	1600 MHz	3200 Mbps	Commercial, Industrial	AS4C512M16D4A-62BxN
8Gb	512M x 16	1.2V	96-ball FBGA (7.5x13mm)	1600 MHz	3200 Mbps	Automotive Temperature -40 °C to 105 °C	AS4C512M16D4A-62BAN
8Gb	1G x 8	1.2V	78-ball FBGA (7.5x12mm)	1333 MHz	2666 Mbps	Commercial, Industrial	AS4C1G8D4-75BxN
8Gb	1G x 8	1.2V	78-ball FBGA (7.5x12mm)	1600 MHz	3200 Mbps	Commercial, Industrial	AS4C1G8D4A-62BxN
16Gb	1G x 16	1.2V	96-ball FBGA (9x13mm)	1600 MHz	3200 Mbps	Commercial	MT40A1G16KH-062E
16Gb	1G x 16	1.2V	96-ball FBGA (9x13mm)	1600 MHz	3200 Mbps	Commercial	AS4C1G16D4-062BCN

# DDR4 Cross Reference

DENSITY	ORG	ALLIANCE	MICRON	NANYA	SAMSUNG	HYNIX	ISSI
4Gb	256M x 16	AS4C256M16D4-83BxN AS4C256M16D4-75BxN	MT40A256M16GE	NT5AD256M16D4	K4A4G165WE	H5AN4G6NBJR	IS43QR16256
4Gb	512M x 8	AS4C512M8D4-83BxN AS4C512M8D4-75BxN	MT40A512M8RH	NT5AD512M8D4	K4A4G085WE	H5AN4G8NBJR	IS43QR85120
4Gb	256M x 16	AS4C256M16D4A-62BxN AS4C256M16D4A-75BxN	MT40A256M16GE	NT5AD256M16D4	K4A4G165WE	H5AN4G6NBJR	IS43QR16256
4Gb	512M x 8	AS4C512M8D4A-75BxN	MT40A512M8RH	NT5AD512M8D4	K4A4G085WE	H5AN4G8NBJR	IS43QR85120
8Gb	512M x 16	AS4C512M16D4-75BxN AS4C512M16D4A-62BxN	MT40A512M16LY/JY	NT5AD512M16C4	K4A8G165WB/C	H5AN8G6NCJR	IS43QR16512A IS46QR16512A
8Gb	1G x 8	AS4C1G8D4-75BxN AS4C1G8D4A-62BxN	MT40A1G8SA/WE	NT5AD1024M8C3	K4A8G085WB/C	H5AN8G8NCJR	IS43QR81024A
16Gb	1G x 16	MT40A1G16KH-062E AS4C1G16D4-062BCN	MT40A1G16KH/KNR		K4AAG165WA-BCWE	H5ANAG6NCMR-XNC H5ANAG6NDRM-XNC	

# MOBILE LOW POWER SDRAM

DENSITY	ORG	VCC	PACKAGE	CLOCK FREQUENCY	TEMPERATURE OPTIONS	ALLIANCE
128Mb	8M x 16	1.7V ~ 1.95V	54-ball FBGA (8x8mm)	166 MHz	Industrial -40°C ~ +85°C	AS4C8M16MSA-6BIN AS4C8M16MSB-6BIN
256Mb	16M x 16	1.7V ~ 1.95V	54-ball FBGA (8x8mm)	166 MHz	Industrial -40°C ~ +85°C	AS4C16M16MSA-6BIN AS4C16M16MSB-6BIN
256Mb	8M x 32	1.7V ~ 1.95V	90-ball FBGA (8x13mm)	166 MHz	Industrial -40°C ~ +85°C	AS4C8M32MSB-6BIN
512Mb	32M x 16	1.7V ~ 1.95V	54-ball FBGA (8x8mm)	166 MHz	Industrial -40°C ~ +85°C	AS4C32M16MSA-6BIN AS4C32M16MSB-6BIN
512Mb	16M x 32	1.7V ~ 1.95V	90-ball FBGA (8x13mm)	166 MHz	Industrial -40°C ~ +85°C	AS4C16M32MSA-6BIN AS4C16M32MSB-6BIN

## MOBILE LOW POWER SDRAM Cross Reference

DENSITY	ALLIANCE	MICRON	ISSI	NANYA	WINBOND
128Mb	AS4C8M16MSA-6BIN AS4C8M16MSB-6BIN		IS42VM16800H		W987D6HBGX
256Mb	AS4C16M16MSA-6BIN AS4C16M16MSB-6BIN	MT48H16M16LFBF (EOL)	IS42VM16160K		W988D6FBGX
256Mb	AS4C8M32MSB-6BIN	MT48H8M32LFB5 (EOL)	IS42VM32800K		W988D2FBJX
512Mb	AS4C32M16MSA-6BIN AS4C32M16MSB-6BIN	MT48H32M16LFB4-6 IT	IS42VM16320E	NT6SM32M16BG-S1	W989D6DBGX
512Mb	AS4C16M32MSA-6BIN AS4C16M32MSB-6BIN	MT48H16M32LFB5-6 IT	IS42VM32160E	NT6SM16M32BK-S1	W989D2DBJX

# MOBILE LOW POWER DDR1

DENSITY	ORG	VCC	PACKAGE	CLOCK FREQUENCY	DATA RATE	TEMPERATURE OPTIONS	ALLIANCE
256Mb	16M x 16	1.8V	60-ball FBGA (8x9mm)	166 MHz	333Mbps	Extended -30°C ~ +85°C	AS4C16M16MD1-6BCN
512Mb	32M x 16	1.8V	60-ball FBGA (8x9mm)	200 MHz	400Mbps	Extended -30°C ~ +85°C	AS4C32M16MD1A-5BCN
512Mb	16M x 32	1.8V	90-ball FBGA (8x13mm)	200 MHz	400Mbps	Extended -25°C ~ +85°C Industrial -40°C ~ +85°C	AS4C16M32MD1-5BxN
1Gb	64M x 16	1.8V	60-ball FPBGA (8x9mm)	200 MHz	400Mbps	Industrial -40°C ~ +85°C	AS4C64M16MD1A-5BIN
1Gb	32M x 32	1.8V	90-ball FBGA (8x13mm)	200 MHz	400Mbps	Industrial -40°C ~ +85°C	AS4C32M32MD1A-5BIN
2Gb	64M x 32	1.8V	90-ball FBGA (8x13mm)	200 MHz	400Mbps	Extended -25°C ~ +85°C Industrial -40°C ~ +85°C	AS4C64M32MD1-5BxN
2Gb	64M x 32	1.8V	90-ball FBGA (8x13mm)	200 MHz	400Mbps	Industrial -40°C ~ +85°C	AS4C64M32MD1A-5BIN

## MOBILE LOW POWER DDR1 Cross Reference

DENSITY	ALLIANCE	MICRON	SAMSUNG	ISSI	HYNIX	NANYA	ELITE (ESMT)	WINBOND
256Mb	AS4C16M16MD1-6BCN	MT46H16M16LFBF-6	K4X56163SPN	IS43LR16160	HY5MS5B6/ H5MS2562	NT6DM16M16AD-T1	M53D2561616A-6BG2F	W948D6FBHX
512Mb	AS4C32M16MD1A-5BCN	MT46H32M16LFBF-5	K4X51163PI	IS43R16320B	HY5MS7B6/ H5MS5162	NT6DM32M16A(B)D-T1	M53D5121632A-5BG2T	W949D6DBHX
512Mb	AS4C16M32MD1-5BxN	MT46H16M32LFB5-5	K4X51323PI	IS43LR32160B	H5MS5132/ H5MS5122	NT6DM16M32A(B)C-T1	M53D5123216A-5BG2S	W949D2DBJX
1Gb	AS4C64M16MD1A-5BIN	MT46H64M16LFBF	K4X1G163PE	IS43LR16640A	H5MS1G62			
1Gb	AS4C32M32MD1A-5BIN	MT46H32M32LFB5-5	K4X1G323PF	IS43LR32320B	H5MS1G22	NT6DM32M32BC-T1	M53D1G3232A	W94AD2KBJX
2Gb	AS4C64M32MD1-5BxN	MT46H64M32LFBQ-5	K4X2G323PC	IS43LR32640A	H5M52G22			
2Gb	AS4C64M32MD1A-5BIN	MT46H64M32LFBQ-5	K4X2G323PC	IS43LR32640A	H5M52G22			

# MOBILE LOW POWER DDR2

DENSITY	ORG	VCC	PACKAGE	CLOCK FREQUENCY (MHz)	DATA RATE	TEMPERATURE OPTIONS	ALLIANCE
256Mb	8M x 32	1.2V/1.8V	134-ball FBGA	400 MHz	800Mbps	Extended -25°C ~ +85°C	AS4C8M32MD2A-25BCN
256Mb	8M x 32	1.2V/1.8V	168-ball POP FBGA	400 MHz	800Mbps	Extended -25°C ~ +85°C	AS4C8M32MD2A-25BPCN
1Gb	64M x 16	1.2V/1.8V	134-ball FBGA	400 MHz	800Mbps	Industrial -40°C ~ +85°C	AS4C64M16MD2A-25BIN
1Gb	32M x 32	1.2V/1.8V	134-ball FBGA	400 MHz	800Mbps	Industrial -40°C ~ +85°C	AS4C32M32MD2A-25BIN
2Gb	128M x 16	1.2V/1.8V	134-ball FBGA	400MHz	800Mbps	Industrial -40°C ~ +85°C	AS4C128M16MD2A-25BIN
2Gb	64M x 32	1.2V/1.8V	134-ball FBGA	400 MHz	800Mbps	Industrial -40°C ~ +85°C	AS4C64M32MD2A-25BIN
4Gb	128M x 32	1.2V/1.8V	134-ball FBGA	533 MHz	1066Mbps	Industrial -40°C ~ +85°C	AS4C128M32MD2A-18BIN
4Gb	128M x 32	1.2V/1.8V	134-ball FBGA	400 MHz	800Mbps	Industrial -40°C ~ +85°C	AS4C128M32MD2A-25BIN

# MOBILE LOW POWER DDR2 Cross Reference

DENSITY	ALLIANCE	MICRON	SAMSUNG	ISSI	HYNIX	NANYA	ELITE (ESMT)	WINBOND
256Mb	AS4C8M32MD2A-25B(PC)N			IS43LD32800A-25BLx IS43LD32800B-25BLx				W978H2KBVX2E
1Gb	AS4C64M16MD2A-25BIN	MT42L64M16D1HE-25		IS43LD16640C/A		NT6TL64M16BA(I)-GO		W97AH6KBVX2
1Gb	AS4C32M32MD2A-25BIN	MT42L32M32D1HE-25		IS43LD32320C/A		NT6TL32M32BI(A)-GO		W97AH2KBVX2
2Gb	AS4C128M16MD2A-25BIN	MT42L128M16D1TK-25		IS43LD16128B		NT6TL128M16CI(A)-GO		W97BH6KBVX2
2Gb	AS4C64M32MD2A-25BIN	MT42L64M32D1TK-25		IS43LD32640B		NT6TL64M32CI(A)-GO		W97BH2KBVX2
4Gb	AS4C128M32MD2A-18BIN	MT42L128M32D1GU-18		IS43LD32128A		NT6TL128M32BI(A)-GO		
4Gb	AS4C128M32MD2A-25BIN	MT42L128M32D1GU-18		IS43LD32128A		NT6TL128M32BI(A)-GO		



# LPDDR4

DENSITY	ORG	VDD1 / VDD2 / VDDQ	PACKAGES	CLOCK FREQUENCY	DATA RATE	TEMPERATURE OPTIONS	ALLIANCE	REMARKS
2Gb	128M x 16	1.8V / 1.1V / 1.1V	200b TFBGA (10x14.5mm)	1600 MHz	3200 Mbps	Automotive A2 (-40°C to 105°C)	AS4C128M16MD4-062BAN	With ECC
2Gb	64M x 32	1.8V / 1.1V / 1.1V	200b TFBGA (10x14.5m)	1600 MHz	3200 Mbps	Automotive A2 (-40°C to 105°C)	AS4C64M32MD4-062BAN	With ECC
4Gb	128M x 32	1.8V / 1.1V / 1.1V	200b TFBGA (10x14.5m)	1600 MHz	3200 Mbps	Automotive A2 (-40°C to 105°C)	AS4C128M32MD4-062BAN	With ECC
4Gb	256M x 16	1.8V / 1.1V / 1.1V	200b TFBGA (10x14.5m)	1600 MHz	3200 Mbps	Automotive A2 (-40°C to 105°C)	AS4C256M16MD4-062BAN	With ECC
8Gb	256M x 32	1.8V / 1.1V / 1.1V	200b TFBGA (10x14.5m)	1600 MHz	3200 Mbps	Automotive A2 (-40°C to 105°C)	AS4C256M32MD4-062BAN	With ECC

# LPDDR4X

DENSITY	ORG	VDD1 / VDD2 / VDDQ	PACKAGES	CLOCK FREQUENCY	DATA RATE	TEMPERATURE OPTIONS	ALLIANCE	REMARKS
2Gb	128M x 16	1.8V / 1.1V / 0.6V	200b TFBGA (10x14.5mm)	1600 MHz	3200 Mbps	Automotive A2 (-40°C to 105°C)	AS4C128M16MD4V-062BAN	With ECC
4Gb	256M x 16	1.8V / 1.1V / 0.6V	200b TFBGA (10x14.5mm)	1600 MHz	3200 Mbps	Automotive A2 (-40°C to 105°C)	AS4C256M16MD4V-062BAN	With ECC
8Gb	256M x 32	1.8V / 1.1V / 0.6V	200b TFBGA (10x14.5mm)	1600 MHz	3200 Mbps	Automotive A2 (-40°C to 105°C)	AS4C256M32MD4V-062BAN	With ECC
8Gb	512M x 16	1.8V / 1.1V / 0.6V	200b TFBGA (10x15mm)	1866 MHz	3733 Mbps	Industrial (-40C to 85C)	AS4C512M16MD4V-053BIN	without ECC
16Gb	512M x 32	1.8V / 1.1V / 0.6V	200b TFBGA (10x15mm)	1866 MHz	3733 Mbps	Industrial (-40C to 85C)	AS4C512M32MD4V-053BIN	without ECC
16Gb	512M x 32	1.8V / 1.1V / 0.6V	200b TFBGA (10x15mm)	2133 MHz	4266 Mbps	Industrial (-40C to 95C)	AS4C512M32MD4V-046BIN	without ECC
32Gb	1Gb x 32	1.8V / 1.1V / 0.6V	200b TFBGA (10x15mm)	2133 MHz	4266 Mbps	Industrial (-40C to 95C)	AS4C1G32MD4V-046BIN	without ECC

# LPDDR4 Cross Reference

DENSITY	ORG	ALLIANCE	MICRON	SAMSUNG	HYNIX	NANYA	ISSI	WINBOND	IM
2Gb	128M x 16	AS4C128M16MD4-062BAN	MT53E128M16D1DS		H9HCNNNBKUMMLXR/HR	NT6AN128M16AV	IS43/46LQ16128A IS43/46LQ16128EA	W66BL6NBU W66BP6NBU	
2Gb	64M x 32	AS4C64M32MD4-062BAN					IS43/46LQ32640A IS43/46LQ32640EA	W66CL2NQU W66CP2NQU W66CP2NQQ	
4Gb	128M x 32	AS4C128M32MD4-062BAN	MT53B128M32D1DS MT53E128M32D2DS MT53E128M32D2FW	K4F4E3S4HF-GFCJ K4F4E3S4HF-GHCJ		NT6AN128T32AV	IS43/46LQ32128A IS43/46LQ32128EA	W66CL2NQU W66CP2NQU	IME4G32L4HABG
4Gb	256M x 16	AS4C256M16MD4-062BAN	MT53E256M16D1DS MT53E256M16D1FW		H9HCNNN4KUMMLHR	NT6AN256M16AV	IS43/46LQ16256A IS43/46LQ16256EA	W66CP6NBU W66CL6NBU	
8Gb	256M x 32	AS4C256M32MD4-062BAN	MT53B256M32D1DS MT53E256M32D2DS MT53E256M32D2FW	K4F8E304HB-MGCJ K4F8E3S4HB-MFCJ K4F8E3S4HB-MHCJ	H9HCNNN8KUMMLHR	NT6AN256T32AV	IS43/46LQ32256A IS43/46LQ32256EA	W66DP2NQU W66DL2NQU	IME8G32L4HADG

# LPDDR4X Cross Reference

DENSITY	ORG	ALLIANCE	MICRON	SAMSUNG	HYNIX	NANYA	ISSI	WINBOND	IM
2Gb	128M x 16	AS4C128M16MD4V-062BAN					IS43/46LQ16128AL IS43/46LQ16128EA	W66BQ6NBU	
4Gb	256M x 16	AS4C256M16MD4V-062BAN	MT53E256M16D1DS MT53E256M16D1FW	K4U8E3S4AD-GFCL K4U8E3S4AD-GHC	H9HCNNN4KMMLHR	NT6AP256M16AV	IS43/46LQ16256AL IS43/46LQ16256EA	W66CQ6NQU	IM4G16L4JCBG
8Gb	256M x 32	AS4C256M32MD4V-062BAN	MT53B256M32D1DS MT53E256M32D2DS MT53E256M32D2FW	K4U8E3S4Ax		NT6AP256T32AV	IS43/46LQ32256AL IS43/46LQ32256EAL	W66DQ2NQU	IM8G32L4JCBG
8Gb	512M x 16	AS4C512M16MD4V-053BIN	MT53D512M16D1DS MT53E512M16D1FW			NT6AP512M16AV	IS43LQ16512AL		IM8G16L4JC-BG-046
16Gb	512M x 32	AS4C512M32MD4V-053BIN	MT53D512M32D2Dx MT53D512M32D1ZW MT53D512M32D2FW	K4U6E3S4Ax	H9HCNNNBPUMLHR	NT6AP512T32BY			IMAG32L4JC-BG-046
16Gb	512M x 32	AS4C512M32MD4V-046BIN	MT53D512M32D2Dx MT53E512M32D2FW MT53E512M32D1ZW	K4U6E3S4Ax	H9HCNNNBKUMMLXR H9HCNNNBPUMLHR	NT6AP512T32BY			IMAG32L4JC-BG-046
32Gb	1G x 32	AS4C1G32MD4V-046BIN	MT53D1024M32D4Dx MT53E1G32D2FW MT53E1G32D2Nx	K4UBE3D4Ax	H9HCNNNCPMMLXR H9HCNNNCPMMLXR	NT6AP1024F32B			

# 5V FAST ASYNCHRONOUS SRAM

DENSITY	ORG	VCC	PACKAGES	TEMPERATURE	SPEED (NS)	ALLIANCE
64Kb	8K x 8	5V	28pin SOJ (300mils), Skinny 28pin PDIP (300mils)	Commercial 0°C ~ +70°C Industrial -40°C ~ +85°C	15	AS7C164A
256Kb	32K x 8	5V	28pin SOJ (300mils), 28pin TSOP I (8x13.4mm)	Commercial 0°C ~ +70°C Industrial -40°C ~ +85°C	10,12,15,20	AS7C256A
256Kb	32K x 8	5V	28pin PDIP (300mils)	Industrial -40°C ~ +85°C	15	AS7C256B
512Kb	32K x 16	5V	44pin SOJ (400mils), 44pin TSOP II (400mils)	Commercial 0°C ~ +70°C	12,15	AS7C513B
1Mb	128K x 8	5V	32pin SOJ (300mils & 400mils), 32pin TSOP I (8x13.4mm) Corner Vcc & Gnd	Commercial 0°C ~ +70°C Industrial -40°C ~ +85°C	12,15,20	AS7C1024B
1Mb	128K x 8	5V	32pin SOJ (300mils & 400mils), Center Vcc & Gnd	Commercial 0°C ~ +70°C Industrial -40°C ~ +85°C	10,12,15	AS7C1025B
1Mb	64K x 16	5V	44pin SOJ (400mils), 44pin TSOP II (400mils)	Commercial 0°C ~ +70°C Industrial -40°C ~ +85°C	10,12,15,20	AS7C1026B
4Mb	512K x 8	5V	36pin SOJ (400mils), 44pin TSOP II (400mils)	Commercial 0°C ~ +70°C Industrial -40°C ~ +85°C	10,12,15,20	AS7C4096A
4Mb	256K x 16	5V	44pin SOJ (400mils), 44pin TSOP II (400mils)	Commercial 0°C ~ +70°C Industrial -40°C ~ +85°C	10,12,15,20	AS7C4098A

## 3.3V FAST ASYNCHRONOUS SRAM

DENSITY	ORG	VCC	PACKAGES	TEMPERATURE	SPEED (NS)	ALLIANCE
256Kb	32K x 8	3.3V	28pin SOJ (300mils), 28pin TSOP I (8x13.4mm)	Commercial Industrial	10,12,15,20	AS7C3256A
512Kb	32K x 16	3.3V	44pin SOJ (400mils), 44pin TSOP II (400mils)	Commercial	10,12,15,20	AS7C3513B
1Mb	128K x 8	3.3V	32pin SOJ (300 & 400mils), 32pin TSOP I (8x13.4mm), Corner Vcc & Gnd	Commercial	10,12,15,20	AS7C31024B
1Mb	128K x 8	3.3V	32pin SOJ (300 & 400mils), Center Vcc & Gnd	Commercial Industrial	10,12,15,20	AS7C31025B
1Mb	64K x 16	3.3V	44pin SOJ (400mils), 44pin TSOP II (400mils)	Commercial Industrial	10,12,15,20	AS7C31026B
2Mb	128K x 16	3.3V	44pin TSOP II (400mils)	Commercial Industrial	10,12,15,20	AS7C32098A
2Mb	256K x 8	3.3V	44pin TSOP II (400mils)	Commercial Industrial	10,12,15,20	AS7C32096A
4Mb	512K x 8	3.3V	36pin SOJ (400mils), 44pin TSOP II (400mils), 36b TFBGA (6x8mm)	Commercial Industrial	8,10,12,15,20	AS7C34096A / B
4Mb	256K x 16	3.3V	44pin SOJ (400mils), 44pin TSOP II (400mils), 48b TFBGA (6x8mm, 8x10mm)	Commercial Industrial	8,10,12,15,20	AS7C34098A / B
8Mb	1M x 8	3.3V	44pin TSOP II (400mils), 48b TFBGA (6x8mm)	Industrial	10	AS7C38096A / B
8Mb	512K x 16	3.3V	44pin TSOP II (400mils), 48b TFBGA (6x8mm)	Industrial	10	AS7C38098A
8Mb	256K x 32	3.3V	90b TFBGA (8x13mm)	Industrial	10	AS7C325632
16Mb	512K x32	3.3V	90b TFBGA (9x13mm)	Industrial	10	AS7C351232
16Mb	1M x 16	3.3V	48b TFBGA (6x8mm), 48pin TSOP I (12x20mm), 54pin TSOP II (400mils)	Industrial	10	AS7C316098A / B
16Mb	2M x 8	3.3V	48b TFBGA (6x8mm), 48pin TSOP I (12x20mm), 44pin TSOP II, 54pin TSOP II	Industrial	10	AS7C316096A / B / C

# FAST ASYNCHRONOUS SRAM Cross Reference

## 64K FAST

ORG	VCC	PACKAGE	SPEED (NS)	ALLIANCE	SAMSUNG	CYPRESS (EOL)	IDT	ISSI
8K x 8	5V	28pin SOJ (300mil)	15	AS7C164A-15JxN		CY7C185-15VI (EOL)	IDT7164SXXYG	IS61C64AL-10JLI (EOL)
8K x 8	5V	28pin Skinny PDIP 300mil	15	AS7C164A-15PxN		CY7C185-20PXC (EOL)		

## 256K FAST

ORG	VCC	PACKAGE	SPEED (NS)	ALLIANCE	SAMSUNG	CYPRESS (EOL)	IDT	ISSI
32K x 8	5V	28pin SOJ	10,12,15,20	AS7C256A-xxJCN/JIN	K6E0808C (EOL)	CY7C199D-XXVXI	IDT71256SAXXYG(EOL)	IS61C256AL-XXJL (EOL)
32K x 8	5V	28pin TSOP I	10,12,15,20	AS7C256A-xxTCN/TIN		CY7C199D-XXZXI	IDT71256SAXXPZG	IS61C256AL-XXTL
32K x 8	3.3V	28pin SOJ	10,12,15,20	AS7C3256A-xxJCN/JIN	K6E0808V	CY7C1399BN-12VXC	IDT71V256SAXXYG	IS61LV256AL-10JL (EOL)
32K x 8	3.3V	28pin TSOP I	10,12,15,20	AS7C3256A-xxTCN/TIN		CY7C1399BN-XXZXI	IDT71V256SAXXPZG	IS61LV256AL-10TL
32K x 8	5V	28pin DIP	15	AS7C256B-xxPIN	(EOL)	CY7C199CN-15PXC (EOL)	IDT71256SAXXTPG	

## 512K FAST

ORG	VCC	PACKAGE	SPEED (NS)	ALLIANCE	SAMSUNG	CYPRESS	IDT	ISSI
32K x 16	5V	44pin SOJ (400mil)	15	AS7C513B-xxJCN		CY7C1020D-10VXI		IS61C321AL-12KLI (EOL)
32K x 16	5V	44pin TSOP II (400mil)	12,15	AS7C513B-xxTCN		CY7C1020D-10ZSXI		IS61C3216AL-12TLI
32K x 16	3.3V	44pin TSOP II (400mil)	12,15,20	AS7C3513B-xxTCN		CY7C1020DV33-10ZSXI		IS61WV3216BLL-12TLI
32K x 16	3.3V	44pin SOJ (400mil)	10,12,15	AS7C3513B-xxJCN		CY7C1020DV33-10VXI		



# FAST ASYNCHRONOUS SRAM Cross Reference

## 1M FAST

ORG	VCC	PACKAGE	SPEED (NS)	ALLIANCE	SAMSUNG (EOL)	CYPRESS	IDT	ISSI
128K x 8	5V	32pin SOJ (400mil)	12,15,20	AS7C1025B-xxJCN/JIN	K6R1008C1D-KI10		IDT71124SXXYG	
128K x 8	3.3V	32pin SOJ (400mil)	10,12,15,20	AS7C31025B-xxJCN/JIN	K6R1008V1D-KI10	CY7C1019DV33-10VXI	IDT71V124SAXXYG	IS63WV1024L-10KLI (EOL)
128K x 8	5V	32pin SOJ (300mil)	10,12,15,20	AS7C1025B-xxTJCN		CY7C1019D-10VXI		
128K x 8	3.3V	32pin SOJ (400mil)	12	AS7C31025C-12JIN				
128K x 8	3.3V	32pin SOJ (300mil)	10,12,15,20	AS7C31025B-xxTJCN		CY7C1018DV33-10VXI	IDT71V124SAXXTYG	IS63WV1288DBLL-10JLI (EOL)
128K x 8	5V	32pin SOJ (400mil)	12,15,20	AS7C1024B-xxJCN/JIN		CY7C109D-10VXI	IDT71024SXXYG	IS61C1024AL-12KLI (EOL)
128K x 8	5V	32pin TSOP I	12,15,20	AS7C1024B-xxTCN		CY7C109D-10ZXI		IS61C1024AL-12TLI
128K x 8	5V	32pin SOJ (300mil)	12,15,20	AS7C1024B-xxTJCN		CY7C1009D-10VXI	IDT71024SXXTYG	IS61C1024AL-12JLI (EOL)
128K x 8	3.3V	32pin SOJ (400mil)	12,15,20	AS7C31024B-xxJCN		CY1019DV33-10VXI		IS63WV1288DBLL-10KLI (EOL)
128K x 8	3.3V	32pin TSOP I	10,12,15,20	AS7C31024B-xxTCN				IS63WV1288DBLL-10HLI
128K x 8	3.3V	32pin SOJ (300mil)	10,12,15,20	AS7C31024B-xxTJCN		CY7C1018DV33-10VXI		IS63WV1288DBLL-10JLI
64K x 16	5V	44pin SOJ (400mil)	10,12,15,20	AS7C1026B-xxJCN/JIN	K6R1016C1D-KI10	CY7C1021D-XXVXC	IDT71016SXXYG	IS61C6416AL-12KLI (EOL)
64K x 16	5V	44pin TSOP II (400mil)	10,12,15,20	AS7C1026B-xxTCN/TIN	K6R1016C1D-UI10	CY7C1021D-XXZSXI	IDT71016SXXPHG	IS61C6416AL-12TLI
64K x 16	3.3V	44pin SOJ (400mil)	10,12,15,20	AS7C31026B-xxJCN/TIN	K6R1016V1D-KI10	CY7C1021DV33-XXVXI	IDT71V016SAXXYG	IS61WV6416DBLL-10KLI (EOL)
64K x 16	3.3V	44pin TSOP II (400mil)	10,12,15,20	AS7C31026B-xxTCN/TIN	K6R1016V1D-UI10	CY7C1021DV33-XXZSXI	IDT71V016SAXXPHG	IS61WV6416DBLL-10TLI

## 2M FAST

ORG	VCC	PACKAGE	SPEED (NS)	ALLIANCE	SAMSUNG	CYPRESS	IDT	ISSI	GSI
128K x 16	3.3V	44pin TSOP II	10,12,15,20	AS7C32098A-xxTxN		CY7C1011DV33-10ZSXI		IS61WV12816DBLL-10TL	GS72116AGP-XX
256K x 8	3.3V	44pin TSOP II	10,12,15,20	AS7C32096A-xxTxN		CY7C1010DV33-10ZSXI		IS61WV256EDBLL-10TLI	GS72108AGP-XX

# FAST ASYNCHRONOUS SRAM Cross Reference

## 4M FAST

ORG	VCC	PACKAGE	SPEED (NS)	ALLIANCE	SAMSUNG	CYPRESS	IDT	ISSI
512K x 8	5V	36pin SOJ (400mil)	10,12,15,20	AS7C4096A-xxJxN	K6R4008C1D-KI10	CY7C1049D-10VXI		IS61C5128AL-10KLI (EOL)
512K x 8	5V	44pin TSOP II (400mil)	10,12,15,20	AS7C4096A-xxTxN	K6R4008C1D-UI10			IS61C5128AL-10TLI
512K x 8	3.3V	36pin SOJ (400mil)	8,10,12,15,20	AS7C34096A-xxJxN	K6R4008V1D-KI10	CY7C1049DV33-10VXI	IDT71V424SXXYG	IS61WV5128EDBLL-10KLI (EOL)
512K x 8	3.3V	44pin TSOP II (400mil)	10,12,15,20	AS7C34096A-xxTxN	K6R4008V1D-UI10	CY7C1049DV33-10ZSI	IDT71V424SXXPHG	IS61WV5128EDBLL-10TLI
512K x 8	2.7 ~ 3.6V	44pin TSOP II	10	AS7C34096B-10TIN				
512K x 8	2.7 ~ 3.6V	36ball TFBGA	10	AS7C34096B-10BIN				
256K x 16	5V	44pin SOJ (400mil)	10,12,15,20	AS7C4098A-xxJxN	K6R4016C1D-KI10	CY7C1041D-10VXI		IS61C25616AL-10KLI (EOL)
256K x 16	5V	44pin TSOP II (400mil)	10,12,15,20	AS7C4098A-xxTxN	K6R4016C1D-UI10	CY7C1041D-10ZSXI		IS61C25616AL-10TL
256K x 16	3.3V	44pin SOJ (400mil)	10,12,15,20	AS7C34098A-xxJxN	K6R4016V1D-KI10	CY7C1041DV33-10VXI	IDT71V416SXXYG	
256K x 16	3.3V	44pin TSOP II (400mil)	8,10,12,15,20	AS7C34098A-xxTxN	K6R4016V1D-UI10	CY7C1041DV33-10ZSXI	IDT71V416SXXPHG	IS61WV25616EDBLL-10TLI
256K x 16	3.3V	48ball TFBGA	10	AS7C34098A-xxBIN		CY7C1041DV33-10BVXI	IDT71V416SXXBE	IS61WV25616EDBLL-10BLI
256K x 16	2.7 ~ 3.6V	44pin TSOP II	10	AS7C34098B-10TIN				
256K x 16	2.7 ~ 3.6V	48ball TFBGA	10	AS7C34098B-10BIN				

## 8M FAST

ORG	VCC	PACKAGE	SPEED (NS)	ALLIANCE	SAMSUNG	CYPRESS	IDT	ISSI	GSI
512K x 16	3.3V	44pin TSOP II	10	AS7C38098A-10TIN		CY7C1051DV33-10ZSXI		IS61WV51216BLL-XXTLI	
512K x 16	3.3V	48ball TFBGA	10	AS7C38098A-10BIN		CY7C1051DV33-10BAXI		IS61WV51216BLL-10MLI	
256K x 32	3.3V	90ball TFBGA	10	AS7C325632-10BIN				IS61WV25632BLL-10BLI	
1M x 8	3.3V	44pin TSOP II	10	AS7C38096A-10TIN		CY7C1059DV33-10ZSXI		IS61WV10248BLL-10TLI	
1M x 8	3.3V	48ball TFBGA (different pinout)	10	AS7C38096A-10BIN					
1M x 8	3.3V	48ball TFBGA (different pinout)	10	AS7C38096B-10BIN				IS61WV10248BLL-10MLI	

# FAST ASYNCHRONOUS SRAM Cross Reference

## 16M FAST

ORG	VCC	PACKAGE	SPEED (NS)	ALLIANCE	SAMSUNG	CYPRESS	IDT	ISSI	GSI
1M x 16	3.3V	48pin TSOP I	10	AS7C316098A-10TIN		CY7C1061GN30-10ZXI		IS61WV102416FBLL-10TLI	
1M x 16	3.3V	48ball TFBGA	10	AS7C316098A-10BIN		CY7C1061GN30-10BV1XI		IS61WV102416FBLL-10BLI	
1M x 16	3.3V	54pin TSOP II	10	AS7C316098B-10TIN		CY7C1061GN30-10ZSXI		IS61WV102416FBLL-10T2LI	
1M x 16	3.3V	48ball TFBGA	10	AS7C316098B-10BIN					
2M x 8	3.3V	48pin TSOP I	10	AS7C316096A-10TIN		CY7C1069GN30-10ZSXI		IS61WV20488FBLL-10T2LI	
2M x 8	3.3V	54pin TSOP II	10	AS7C316096B-10TIN		CY7C1069DV33-10ZSXI			
2M x 8	3.3V	44pin TSOP II	10	AS7C316096C-10TIN				IS61WV20488FBLL-10TLI	
2M x 8	3.3V	48ball TFBGA (1CE)	10	AS7C316096C-10BIN				IS61WV20488FBLL-10BLI	
2M x 8	3.3V	48ball TFBGA (2CE)	10	AS7C316096B-10BIN		CY7C1069GN30-10BVXI			
512K x 32	3.3V	90ball TFBGA	10	A7C351232-10BIN				IS61WV51232BLL-10BLI	

## 2.7V- 3.6V LOW POWER SRAMS

DENSITY	ORG	VCC	PACKAGES	SPEED (NS)	ALLIANCE
256Kb	32K x 8	2.5 ~ 3.6V	28pin SOP (330mm)	70	AS62V256A-70SIN
1Mb	64K x16 with ECC	2.7 ~ 3.6V	44pin TSOP II (400mils)	45	AS6CE1016A-45ZIN
2Mb	256K x 8	2.7 ~ 3.6V	32pin SOP(450mils), 32pin TSOP I (8x20mm), 32pin STSOP (8x13.4mm), 36ball TFBGA (6x8mm)	55	AS6C2008
4Mb	256K x 16	2.7 ~ 3.6V	44pin TSOP II (400mils), 48ball TFBGA (6x8mm)	45	AS6C4016B
4Mb	256K x16 with ECC	2.7 ~ 3.6V	44pin TSOP II (400mils), 48ball TFBGA (6x8mm)	45	AS6CE4016B
8Mb	1M x 8	2.7 ~ 3.6V	44pin TSOP II (400mils), 48ball TFBGA (6x8mm)	45/55	AS6C8008B
8Mb	512K x 16	2.7 ~ 3.6V	44pin TSOP II (400mils), 48ball TFBGA (6x8mm)	45/55	AS6C8016B
16Mb	1M x 16	2.7 ~ 3.6V	48pin TSOP I (12x20mm)	55	AS6C1616-55TIN
16Mb	1M x 16	2.7 ~ 3.6V	48pin TSOP I (12x20mm), 48ball TFBGA (6x8mm)	45/55	AS6C1616B
16Mb	1M x 16 / 2M x 8	2.7 ~ 3.6V	48pin TSOP I (12x20mm)	45	AS6C1616C-45TIN
16Mb	2M x 8	2.7 ~ 3.6V	44pin TSOP II (400mils), 48ball TFBGA (6x8mm)	45	AS6C1608B
32Mb	2M x 16 / 4M x 8	2.7 ~ 3.6V	48pin TSOP I (12x20mm) , 48ball TFBGA (8x10mm)	55	AS6C3216A
64Mb	4M x 16 / 8M x 8	2.7 ~ 3.6V	48pin TSOP I (12x20mm), 48ball TFBGA (8x10mm) (dual chip select)	55	AS6C6416

## 2.7V - 5.5V LOW POWER SRAMS

DENSITY	ORG	VCC	PACKAGES	SPEED (NS)	ALLIANCE
64Kb	8K x 8	2.7 ~ 5.5V	28pin PDIP (600mils), 28pin SOP (330mils), 28pin sTSOP (8x13.4mm)	55	AS6C6264
256Kb	32K x 8	2.7 ~ 5.5V	28pin PDIP (600mils), 28pin SOP (330mils), 28pin sTSOP (8x13.4mm)	55	AS6C62256
1Mb	64K x 16	2.7 ~ 5.5V	44pin TSOP II (400mils), 48ball TFBGA (6x8mm)	55	AS6C1016
1Mb	128K x 8	2.7 ~ 5.5V	32p SOP (450mils), 32p TSOP I (8x20mm), 32p sTSOP (8x13.4mm), 36b TFBGA (6x8mm), 32p PDIP (600mils)	55	AS6C1008
2Mb	256K x 8	2.7 ~ 5.5V	32p SOP (450mils), 32p TSOP I (8x20mm), 32p sTSOP (8x13.4mm), 36b TFBGA (6x8mm)	55	AS6C2008A
2Mb	128K x 16	2.7 ~ 5.5V	44pin TSOP II (400mils), 48b TFBGA (6x8mm)	55	AS6C2016
4Mb	512K x 8	2.7 ~ 5.5V	32p SOP (450mils), 32p TSOP I (8x20mm), 32p sTSOP (8x13.4mm), 36b TFBGA (6x8mm), 32p TSOP II (400mils)	55	AS6C4008
4Mb	512K x 8	2.7 ~ 5.5V	32p SOP (450mils)	70	AS6C4008-70SAN
4Mb	256K x 16	2.7 ~ 5.5V	44pin TSOP II (400mils), 48ball TFBGA (6x8mm)	55	AS6C4016
8Mb	1M x 8	2.7 ~ 5.5V	44pin TSOP II (400mils), 48ball TFBGA (6x8mm)	55	AS6C8008
8Mb	512K x 16	2.7 ~ 5.5V	44pin TSOP II (400mils), 48ball TFBGA (6x8mm) one chip select pins:B5**	55	AS6C8016
8Mb	512K x 16	2.7 ~ 3.6V	48pin TSOP I (12x20mm)	55	AS6C8016-55TIN

# LOW POWER SRAM Cross Reference

## 64K LOW POWER

ORG	VCC	PACKAGE	ALLIANCE	ZMD (EOL)	CYPRESS (EOL)	HITACHI (EOL)	NEC (EOL)	HYNIX (EOL)
8K x 8	2.7V ~ 5.5V	28pin 600mil DIP	AS6C6264-55PCN / PIN	U6264BDC07LLG1		HM6264BLP		HY6264P
8K x 8	2.7V ~ 5.5V	28pin 330mil SOP	AS6C6264-55SCN / SIN	U6264BS2C07LLG1	CY6264-55SNXI	HM6264BLFP	uPD4464	HY6264G
8K x 8	2.7V ~ 5.5V	28pin STSOP (8 x 13.4 mm)	AS6C6264-55STCN					

## 256K LOW POWER

ORG	VCC	PACKAGE	ALLIANCE	ZMD	SAMSUNG (EOL)	CYPRESS (EOL)	RENESAS	BRILLIANCE (EOL)	ISSI
32K x 8	2.7V ~ 5.5V	28pin 600mil DIP	AS6C62256-55PCN	U62256ADC07LLG1	K6X0808C1D-DF55	CY62256NLL-70PXC		BS62LV256PCP-55	
32K x 8	2.7V ~ 5.5V	28pin 330mil SOP	AS6C62256-55SxN	U62256AS2C07LLG1	K6X0808C1D-BF55	CY62256NLL-55SNXI	R1LP5256ESP-5S	BS62LV256SCP-55	IS62C256AL-45ULI
32K x 8	2.4V ~ 3.6V	28pin 330mil SOP	AS62V256-70SIN			CY62256NVLL-70SNXI	R1LV5256ESP-5S	BS62LV256SCP-55	IS62LV256AL-45ULI
32K x 8	2.7V ~ 5.5V	28pin STSOP (8 x 13.4 mm)	AS6C62256-55STxN		K6X0808C1D-LF55	CY62256NLL-55ZRXI	R1LP5256ESA-5S	BS62LV256STCP-55	IS62LV256AL-45TLI

## 1M LOW POWER

ORG	VCC	PACKAGE	ALLIANCE	SAMSUNG (EOL)	CYPRESS	RENESAS	RENESAS	BRILLIANCE (EOL)	NEC (EOL)	ISSI
128K x 8	2.7V ~ 5.5V	32pin 600mil DIP	AS6C1008-55PCN AS6C1008-55PIN	K6X1008C2D-DB55				BS62LV1027PCP-55	uPD431000ACZ-70L	
128K x 8	2.7V ~ 5.5V	32pin 450mil SOP	AS6C1008-55SIN	K6X1008C2D-GF55(Lead)/BF	CY62128ELL-45SXI	M5M51008DFP-55HI	R1LP0108ESP-5SI	BS62LV1027SIP-55	uPD431000AGW-70L	IS62C1024AL-35QLI
128K x 8	2.7V ~ 5.5V	32pin TSOP I (8 x 20 mm)	AS6C1008-55TIN	K6X1008C2D-TF55 or PF	CY62128ELL-45ZXI	M5M51008DVP-55HI	R1LP0108ESF-5SI	BS62LV1027TIP-55	uPD431000AGZ-70LL- KKH	IS62C1024AL-35TLI
128K x 8	2.7V ~ 5.5V	32pin STSOP (8 x 13.4 mm)	AS6C1008-55STIN		CY62128ELL-45ZAXI	M5M51008DKV-55HI	R1LP0108ESA-5SI	BS62LV1027STIP-55	uPD431000A- GU-B10-9JH	IS62C1024AL-45HLI
64K x 16	2.7V ~ 5.5V	48ball TFBGA	AS6C1016-55BIN	K6F1016U4C-EF55	CY62127DV30LL-55BVXI			BS616LV1010AI-70		IS62WV6416DBLL-45BLI
64K x 16	2.7V ~ 5.5V	44pin TSOP II	AS6C1016-55ZIN		CY62126EV30LL-45SXIT			BS616LV1010EI-70		IS62WV6416DBLL-45TLI
64K x 16	2.7V ~ 3.6V	44pin TSOP II	AS6CE1016A-45ZIN		CY62126EV30LL-45ZSXI					IS61WV6416EEBLL



# LOW POWER SRAM Cross Reference

## 2M LOW POWER

ORG	VCC	PACKAGE	ALLIANCE	SAMSUNG (EOL)	CYPRESS	RENESAS	RENESAS	BRILLIANCE (EOL)	ISSI
256K x 8	2.7V ~ 3.6V	32pin 450mil SOP	AS6C2008-55SIN		CY62138FV30LL-45SXI			BS62LV2006SIP-55	
256K x 8	2.7V ~ 3.6V	32pin TSOP I (8 x 20 mm)	AS6C2008-55TIN		CY62138FV30LL-45ZXI			BS62LV2006TIP-55	IS62WV2568BLL-55TLI
256K x 8	2.7V ~ 3.6V	32pin STSOP (8 x 13.4 mm)	AS6C2008-55STIN	K6F2008V2E-LF70000	CY62138FV30LL-45ZAXI	M5M5V208AKV-55HI	R1LV0208BSA-5SI	BS62LV2006STIP-55	IS62WV2568BLL-55HLI
256K x 8	2.7V ~ 3.6V	36ball TFBGA (6mm x 8mm)	AS6C2008-55BIN		CY62138FV30LL-45BVXI				IS62WV2568BLL-55B2LI
128K x 16	2.7V ~ 5.5V	44pin TSOP II	AS6C2016-55ZIN		CY62136FVLL-70ZSXI	M5M5V216ATP-70HI	R1LV0216-BSB-5SI	BS616LV2016EIP-55	IS62WV12816BLL-55TLI
128K x 16	2.7V ~ 3.6V	48ball TFBGA	AS6C2016-55BIN	K6F2016U4E-EF55000	CY62136FVLL-70BVXI			BS616LV2019AIG-55	IS62WV12816BLL-55B2LI
256K x 8	2.7V ~ 5.5V	32pin 450mil SOP	AS6C2008A-55SIN		CY2138FV30LL-45SXI			BS62LV2006SIP-55	
256K x 8	2.7V ~ 5.5V	32pin TSOP I (8 x 20mm)	AS6C2008A-55TIN		CY2138FV30LL-45ZXI			BS62LV2006TIP-55	IS62WV256BLL-55TLI
256K x 8	2.7V ~ 5.5V	36ball TFBGA (6mm x 8mm)	AS6C2008A-55BIN		CY62138FV30LL-45BVXI				IS62WV256BLL-55B2LI

## 4M LOW POWER

ORG	VCC	PACKAGE	ALLIANCE	SAMSUNG (EOL)	CYPRESS	RENESAS	BRILLIANCE (EOL)	ISSI
512K x 8	2.7V ~ 5.5V	32pin 600mil DIP	AS6C4008-55PCN	K4X4008C1F-DB55			BS62LV4006PCP-55	
512K x 8	2.7V ~ 5.5V	32pin 450mil SOP	AS6C4008-55SIN	K6X4008C1F-GF55 or BF	CY62148ELL-55SXI	R1LV0408CSP-5SI	BS62LV4006SIP-55	IS62C5128BLL-45QLI
512K x 8	2.7V ~ 5.5V	32pin STSOP (8 x 13.4mm)	AS6C4008-55STIN		CY62148ELL-55ZAXI	R1LV0408DSA-5SI	BS62LV4006STIP-55	IS62C512BL-45HLI
512K x 8	2.7V ~ 5.5V	32pin TSOP II	AS6C4008-55ZIN	K6X4008C1F-VF55	CY62148ELL-45ZSXI	R1LV0408DSB-5SI	BS62LV4006ECP55	IS62WV5128DBLL-45T2LI
512K x 8	2.7V ~ 5.5V	36pin TFBGA (6mm x 8mm)	AS6C4008-55BIN		CY62148EV30LL-55BVXI	R1LV0408DBG-5SI		IS62WV5128EBLL-45BLI
256K x 16	2.7V ~ 5.5V	44pin TSOP II	AS6C4016-55ZIN	K6X4016C3F-TF70000	CY62146ELL-45ZSXI		BS616LV4017EIP-55	IS62WV5128BLL-55TLI
256K x 16	2.7V ~ 3.6V	44pin TSOP II	AS6C4016B-45ZIN	K6X4016T3F-TF70000	CY62147EV30LL-45ZSXI	R1LV0414DSB-5SI	BS616LV4017EIP-55	IS62C25616BL-45T2LI
256K x 16	2.7V ~ 3.6V	48ball TFBGA	AS6C4016B-45BIN	K6F4016U6G-EF70000	CY62147EV30LL-45BVXI	RMLV0416EGBG-4S2	BS616LV4017AIP-55	IS62WV25616DBLL-45BLI
256K x 16	2.7V ~ 3.6V	44pin TSOP II	AS6CE4016B-45ZIN	K6X4016T3F-TF70000	CY62147EV30LL-45ZSXI	R1LV0414DSB-5SI	BS616LV4017EIP-55	IS62C25616EDBLL
256K x 16	2.7V ~ 3.6V	48ball TFBGA	AS6CE4016B-45BIN	K6F4016U6G-EF70000	CY62147EV30LL-45BVXI	RMLV0416EGBG-4S2	BS616LV4017AIP-55	IS62C25616EDFA/BLL

# LOW POWER SRAM Cross Reference

## 8M LOW POWER

ORG	VCC	PACKAGE	ALLIANCE	SAMSUNG (EOL)	CYPRESS	RENESAS	RENESAS	RENESAS	BRILLIANCE	ISSI
1M x 8	2.7 ~ 5.5V	44pin TSOP II	AS6C8008-55ZIN	K6X8008(C/T)2B-UF55	CY62158EV30LL-45ZSXI		R1LV0808ASB-5SI	HM62V8100LTTI-5SL	BS62LV8001ECP-55	IS62WV1024BLL-55TLI
1M x 8	2.7 ~ 5.5V	44pin TSOP II	AS6C8008B-45/55ZIN	K6X8008(C/T)2B-UF55	CY62158EV30LL-45ZSXI		R1LV0808ASB-5SI	HM62V8100LTTI-5SL	BS62LV8001ECP-55	IS62WV1024BLL-55TLI
1M x 8	2.7 ~ 5.5V	48ball TFBGA	AS6C8008-55BIN		CY62158EV30LL-45BVXI	EOL		HM62V8100LBPI-5SL	BS62LV8001ECP-55	IS62WV1024BLL-55MLI
1M x 8	2.7 ~ 3.6V	48ball TFBGA	AS6C8008B-45BIN		CY62158EV30LL-45BVXI	EOL		HM62V8100LBPI-5SL	BS62LV8001FIP-55	IS62WV1024BLL-55MLI
512K x 16	2.7 ~ 5.5V	48ball TFBGA (6 x 8mm)*	AS6C8016-55BIN*	K6F8016U6G-FF55	CY62157EV30LL-55BVXI	M5M5W816WG-55HI	R1LV0816ABG-5SI		BS616LV8017ECP55	IS62WV51216BLL-55BLI
512K x 16	2.7 ~ 3.6V	48ball TFBGA (6 x 8mm)**	AS6C8016B-45/55BIN		CY2157EV30LL-45BVXIT					
512K x 16	2.7 ~ 5.5V	44pin TSOP II	AS6C8016-55ZIN	K6X8016(C/T)3B-UF55	CY62157EV30LL-55ZSXI	M5M5W816TP-55HI	R1LV0816ASA-5SI	HM62165114LTT-5SL	BS616LV8017FCP70	IS62WV51216BLL-55T2LI
512K x 16	2.7 ~ 3.6V	44pin TSOP II	AS6C8016B-45/55ZIN		CY62157EV30LL-45ZSXIT					IS62WV51216BLL-55T2LI
512K x 16	2.7 ~ 5.5V	48pin TSOP I	AS6C8016-55TIN		CY62157EV30LL-45ZXIT					IS62WV51216GBLL-45TLI

\* =one chip select pin:B5

\*\* =two chip select pins:B5 and A6

## 16M LOW POWER

ORG	VCC	PACKAGE	ALLIANCE	CYPRESS	RENESAS	BRILLIANCE (EOL)	ISSI
1M x 16	2.7 ~ 3.6V	48pin TSOP I	AS6C1616-55TIN AS6C1616B-45/55TIN	CY62167E30LL-45/55ZXI	R1LV1616RSA-5SI	BS6216LV1611TCP55	IS62WV102416xxLL
1M x 16	2.7 ~ 3.6V	48pin TSOP I	AS6C1616C-45TIN	CY62167E30LL-45/55ZXI	R1LV1616RSA-5SI	BS6216LV1611TCP55	IS62WV102416xxLL
1M x 16	2.7 ~ 3.6V	48ball TFBGA	AS6C1616B-45/55BIN	CY62167DV30LL-xxBVXIT	R1LV1616HBG-4SI	BS6216LV1611FCP70	IS62WV102416xxLL-xxBLI
2M x 8	2.7 ~ 3.6V	44pin TSOP I	AS6C1608B-45TIN	CY62168EV30LL-xxZXI		BS6216LV1600EIP55	IS62WV20488xxLL-xxTLI
2M x 8	2.7 ~ 3.6V	48ball TFBGA	AS6C1608B-45BIN	CY62168DV30LL-xxBVI			IS62WV20488xxLL-xxBLI

# LOW POWER SRAM Cross Reference

## 32M LOW POWER

ORG	VCC	PACKAGE	ALLIANCE	CYPRESS	RENESAS
2M x 16	2.7 ~ 3.6V	48pin TSOP I	AS6C3216A-55TIN*	CY62177EV30LL-55ZXI	R1LV3216RSA-5SI
2M x 16	2.7 ~ 3.6V	48ball TFBGA	AS6C3216A-55BIN	CY62177EV30LL-55BAXI	R1LV3216CSA-5SI

\*48pin TSOP I (please note: dual chip select 4Mx16 or 8Mx8)

## 64M LOW POWER

ORG	VCC	PACKAGE	ALLIANCE	CYPRESS	RENESAS
4M x 16	2.7V ~ 3.6V	48pin TSOP I	AS6C6416-55TIN		R1WV6416RSA-5S
4M x 16	2.7V ~ 3.6V	48ball BGA	AS6C6416-55BIN	CY62187EV30LL-55BAXI	R1WV6416RBG-5S

\*48pin TSOP I (please note: dual chip select 4Mx16 or 8Mx8)

# Parallel 5V NOR Flash

DENSITY	BUS WIDTH	VCC	PACKAGES	TEMPERATURE RANGE	SPEED (NS)	ALLIANCE	REMARKS
1Mb	x8	5V	PLCC 32	-40°C ~ +85°C	55	AS29CF010-55CCIN	Uniform Sector, Industrial Grade
4Mb	x8	5V	PLCC 32	-40°C ~ +85°C	55	AS29CF040-55CCIN	Uniform Sector, Industrial Grade
4Mb	x8, x16	5V	TSOP(I) 48pin	-40°C ~ +85°C	55	M29F400FT5AN6E2	Top Boot, Automotive Grade3
4Mb	x8, x16	5V	TSOP(I) 48pin	-40°C ~ +125°C	55	M29F400FB55N3E2 M29F400FB55N3F2	Bottom Boot, Automotive Grade1
8Mb	x8, x16	5V	TSOP(I) 48pin	-40°C ~ +85°C	55	AS29CF800T-55TIN	Top Boot, Industrial Grade
8Mb	x8, x16	5V	TSOP(I) 48pin	-40°C ~ +85°C	55	AS29CF800B-55TIN	Bottom Boot, Industrial Grade
8Mb	x8, x16	5V	TSOP(I) 48pin	-40°C ~ +85°C	55	M29F800FB5AN6E2 M29F800FB5AN6F2	Bottom Boot, Automotive Grade3
8Mb	x8, x16	5V	TSOP(I) 48pin	-40°C to 125°C	55	M29F800FT55N3E2	Top Boot, Automotive Grade1
16Mb	x8, x16	5V	TSOP(I) 48pin	-40°C ~ +85°C	55	AS29CF160B-55TIN	Bottom Boot, Industrial Grade
16Mb	x8, x16	5V	TSOP(I) 48pin	-40°C ~ +85°C	55	AS29CF160T-55TIN	Top Boot, Industrial Grade
16Mb	x8, x16	5V	TSOP(I) 48pin	-40°C ~ +85°C	55	M29F160FB5AN6F2	Bottom Boot, Automotive Grade3
16Mb	x8, x16	5V	TSOP(I) 48pin	-40°C to 125°C	55	M29F160FT55N3E2	Top Boot, Automotive Grade1

\*Alliance Memory has collaborated with Micron for exclusive rights to continue to supply M29FX marked parts - SOLD NCNR - immediate delivery

# Parallel 5V NOR Flash Cross Reference

DENSITY	VCC	PACKAGE	SPEED (NS)	ALLIANCE	MICRON	CYPRESS / SPANSION	MACRONIX
1Mb	5V	PLCC 32	55	AS29CF010-55CCIN		AM29F010B* (EOL)	
4Mb	5V	PLCC 32	55	AS29CF040-55CCIN	M29F040	AM29F040B	MX29F040C
4Mb	5V	TSOP 48pin	55	M29F400FT5AN6E2	M29F400F	AM29F400BT* (EOL)	MX29F400CTT
4Mb	5V	TSOP 48pin	55	M29F400FB55N3E2 M29F400FB55N3F2	M29F400F	AM29F400BB* (EOL)	MX29F400CBT
8Mb	5V	TSOP 48pin	55	AS29CF800T-55TIN	M29F800F	AM29F800BT* (EOL)	MX29F800C T/B
8Mb	5V	TSOP 48pin	55	AS29CF800B-55TIN	M29F800F	AM29F800BB* (EOL)	MX29F800C T/B
8Mb	5V	TSOP 48pin	55	M29F800FB5AN6E2 M29F800FB5AN6F2	M29F800F	AM29F800BB* (EOL)	MX29F800CBT
8Mb	5V	TSOP 48pin	55	M29F800FT55N3E2	M29F800F	AM29F800BT* (EOL)	MX29F800CTT
16Mb	5V	TSOP 48pin	55	AS29CF160T-55TIN	M29F160F	AM29F160DT* (EOL)	
16Mb	5V	TSOP 48pin	55	AS29CF160B-55TIN	M29F160F	AM29F160DB* (EOL)	
16Mb	5V	TSOP 48pin	55	M29F160FB5AN6F2	M29F160F	AM29F160DB* (EOL)	
16Mb	5V	TSOP 48pin	55	M29F160FT55N3E2	M29F160F	AM29F160DT* (EOL)	

# SLC Parallel NAND Flash

DENSITY	BUS WIDTH	VCC	PACKAGES	TEMPERATURE RANGE	SPEED (NS)	ALLIANCE	REMARKS
1Gb	x8	3.3V	63b FBGA (9x11mm)	Industrial (-40°C to 85°C)	25ns	AS9F31G08SA-25BIN	4bit ECC, 2K page, 64B Spare
2Gb	x8	3.3V	63b FBGA (9x11mm)	Industrial (-40°C to 85°C)	25ns	AS9F32G08SA-25BIN	4bit ECC, 2K page, 128B Spare
4Gb	x8	3.3V	63b FBGA (9x11mm)	Industrial (-40°C to 85°C)	25ns	AS9F34G08SA-25BIN	4bit ECC, 2K page, 128B Spare
8Gb	x8	3.3V	63b FBGA (9x11mm)	Industrial (-40°C to 85°C)	25ns	AS9F38G08SA-25BIN	4bit ECC, 2K page, 128B Spare
4Gb	x8	1.8V	63b FBGA (9x11mm)	Industrial (-40°C to 85°C)	45ns	AS9F14G08SA-45BIN	4bit ECC, 2K page, 128B Spare
8Gb	x8	1.8V	63b FBGA (9x11mm)	Industrial (-40°C to 85°C)	45ns	AS9F18G08SA-45BIN	4bit ECC, 2K page, 128B Spare, DDP
4Gb	x8	1.8V	63b FBGA (9x11mm)	Automotive Grade2 (-40°C to 105°C)	45ns	AS9F14G08SA-45BAN	4bit ECC, 2K page, 64B Spare
8Gb	x8	1.8V	63b FBGA (9x11mm)	Automotive Grade2 (-40°C to 105°C)	45ns	AS9F18G08SA-45BAN	4bit ECC, 2K page, 128B Spare, DDP

# SLC Parallel NAND Flash Cross Reference

DENS.	VCC	TEMP.	ALLIANCE	MICRON	SKY HIGH	CYPRESS	WINBOND	MACRONIX	KIOXIA	ISSI	GIGA DEVICES	ESMT
1Gb	3.3V	-40°C to 85°C	AS9F31G08SA-25BIN	MT29F1G08ABADAH4 MT29F1G08ABAEAH4	S34SL01G200BFI S34ML01G200BFI S34ML01G300BFI	S34ML01G100BFI	W29N01HV W29N01GV	MX30LF1G18AC	TC58NVG0S3HBA	IS34ML01G084	GD9FU1G8F3AL	F59L1G81MB
2Gb	3.3V	-40°C to 85°C	AS9F32G08SA-25BIN	MT29F2G08ABAEAH4 MT29F2G08ABAGAH4	S34SL02G200BFI S34ML02G200BFI S34ML02G300BFI	S34ML02G100BFI	W29N02GV W29N02KV	MX30LF2G18AC	TC58NVG1S3HBA	IS34ML02G084	GD9FU2G8F2AL	F59L2G81A F59L2G81KA
4Gb	3.3V	-40°C to 85°C	AS9F34G08SA-25BIN	MT29F4G08ABADAH4 MT29F4G08ABAEAH4 MT29F4G08ABAFAH4	S34SL04G200BFI S34ML04G200BFI	S34ML04G100BFI	W29N04GV	MX30LF4G18AC	TC58NVG2S0HBA	IS34ML04G084	GD9FU4G8F2AL	F59L4G81XB
8Gb	3.3V	-40°C to 85°C	AS9F38G08SA-25BIN	MT29F8G08ADACAH4	S34ML08G201BFI	S34ML08G101BFI	W29N08GV	MX60LF8G18AC	TH58NVG3S0HBA	IS34ML08G088 IS34ML08G168	GD9FU8G8E2AL	F59D4G81XB F59D4G-81KA
4Gb	1.8V	-40°C to 85°C	AS9F14G08SA-45BIN	MT29F4G08ABDDAH4 MT29F4G08ABBEAH4 MT29F4G08ABBF4H4	S34MS04G200BFI	S34MS04G100BFI	W29N04GZ W29N04GW	MX30UF4G18AC	TC58NYG2S0HBA	IS34MW04G164	GD9FS4G8F2AL	F59D8G81XB
8Gb	1.8V	-40°C to 85°C	AS9F18G08SA-45BIN	MT29F8G08ADBCAH4 MT29F8G08ADBDAH4 MT29F8G08ABBCAH4 MT29F8G08ABDDAH4	S34MS08G201BFI	S34MS08G101BFI	W29N08GW W29N08GZ	MX60UF8G18AC	TH58NYG3S0HBA	IS34MW08G088 IS34MW08G168	GD9FS8G8E2AL	
4Gb	1.8V	-40°C to 105°C	AS9F14G08SA-45BAN	MT29F4G08ABDDAH4-A MT29F4G08ABBEAH4-A	S34MS04G200BFI	S34MS04G100BFV	W29N04GZ W29N04GW			IS35MW04G084	GD9FS4G8F2AL	
8Gb	1.8V	-40°C to 105°C	AS9F18G08SA-45BAN	MT29F8G08ADBDAH4-A	S34MS08G201BFA	S34MS08G101BFA	W29N08GW W29N08GZ				GD9FS8G8E2AL	



# Serial NOR Flash



DENSITY	BUS WIDTH	VCC	PACKAGES	TEMPERATURE RANGE	SPEED (MHz)	ALLIANCE	REMARKS
2Mb	x1	3.3V	8pin SOIC (150mils)	-40°C to 85°C	75	M45PE20-VMN6P	PAGE ERASABLE, 2Mb Serial Flash (256K x 8bits, 1024 pages, 4 Sectors), Industrial Grade
8Mb	x1	3.3V	8pin DFN (6x5mm)	-40°C to 85°C	75	M45PE80-VMP6TG	PAGE ERASABLE 8Mb Serial Flash (1K x 8bits, 4096 pages, 16 Sectors), Industrial Grade, T&R
16Mb	x1	3.3V	8pin SOIC (208mils)	-40°C to 85°C	75	M45PE16-VMW6TG	PAGE ERASABLE, 16MB SERIAL FLASH (2K X 8BITS, 8192 PAGES, 32 SECTORS), INDUSTRIAL GRADE
4Mb	x1, x2	3.3V	8pin SOIC (150mils)	-40°C to 85°C	104	AS25F304MD-10S1IN	4Mb, 3.3V Serial NOR Flash, Dual IO, Industrial Grade, 8pin SOIC (150mils) package
16Mb	x1, x2, x4	3.3V	8pin SOIC (150mils)	-40°C to 85°C	104	AS25F316MQ-10S1IN	16Mb, 3.3V Serial NOR Flash, Multiple IO, Industrial Grade, 8pin SOIC (150mils) Package
32Mb	x1, x2, x4	3.3V	8pin DFN (4x3mm)	-40°C to 125°C	108	N25Q032A13EF4A0F	32Mb Serial NOR Flash, Multiple IO, 64 Sectors, 4KB Sector Erase, Automotive Grade T&R
32Mb	x1, x2, x4	3.3V	8pin SOIC (150mils)	-40°C to 85°C	108	N25Q032A13ESC40G	32Mb Serial NOR Flash, Multiple IO, 64 Sectors, 4KB Sector Erase, Industrial Grade, Tube
32Mb	x1, x2, x4	3.3V	8pin SOIC (150mils)	-40C to 125C	108	N25Q032A13ESCA0F	32Mb Serial NOR Flash, Multiple IO, 64 Sectors, 4KB Sector Erase, Automotive Grade, T&R
32Mb	x1, x2, x4	3.3V	16pin SOIC (300mils)	-40C to 125C	108	N25Q032A13ESFA0F	32Mb Serial NOR Flash, Multiple IO, 64 Sectors, 4KB Sector Erase, Automotive Grade, T&R
64Mb	x1, x2, x4	1.8V	8pin SOIC (208mils)	-40C to 125C	108	N25Q064A11ESEA0F	64Mb Serial NOR Flash, Multiple IO, 128 Sectors, 4KB Sector Erase, Automotive Grade T&R
64Mb	x1, x2, x4	3.3V	8pin DFN (6x5mm)	-40°C to 85°C	108	N25Q064A13EF640E	64Mb Serial NOR Flash, Multiple IO, 128 Sectors, 4KB Sector Erase, Industrial Grade, Tray
64Mb	x1, x2, x4	3.3V	8pin DFN (8x6mm)	-40C to 125C	108	N25Q064A13EF8A0E	64Mb Serial NOR Flash, Multiple IO, 128 Sectors, 4KB Sector Erase, Automotive Grade Tray
64Mb	x1, x2, x4	3.3V	8pin DFN (8x6mm)	-40C to 125C	108	N25Q064A13EF8A0F	64Mb Serial NOR Flash, Multiple IO, 128 Sectors, 4KB Sector Erase, Automotive Grade T&R
64Mb	x1, x2, x4	3.3V	8pin DFN (8x6mm)	-40°C to 85°C*	108	N25Q064A13EF8H0E	64Mb Serial NOR Flash, Multiple IO, 128 Sectors, 4KB Sector Erase, Industrial Grade High Reliability, Tray
64Mb	x1, x2, x4	3.3V	16pin SOIC (300mils)	-40C to 125C	108	N25Q064A13ESFA0F	64Mb Serial NOR Flash, Multiple IO, 128 Sectors, 4KB Sector Erase, Automotive Grade T&R
64Mb	x1, x2, x4	3.3V	8pin SOIC (208mils)	-40°C to 85°C	104	AS25F364MQ-10SIN	64Mb, 3.3V Serial NOR Flash, Multiple IO, Default Feature1, Industrial Grade, 8SOIC Wide Body Package
64Mb	x1, x2, x4	3.3V	8L WSON (6x5mm)	-40°C to 85°C	104	AS25F364MQ-10WIN	64Mb, 3.3V Serial NOR Flash, Multiple IO, Default Feature1, Industrial Grade, 8WSON Package
128Mb	x1, x2, x4	1.8V	8pin SOIC (208mils)	-40°C to 85°C	133	AS25F128MQ-70SIN	128Mb, 1.8V Serial NOR Flash, Multiple IO, Default Feature1, Industrial Grade, 8SOIC Wide Body Package
128Mb	x1, x2, x4	1.8V	8L WSON (6x5mm)	-40°C to 85°C	133	AS25F128MQ-70WIN	128Mb, 1.8V Serial NOR Flash, Multiple IO, Default Feature1, Industrial Grade, 8WSON Package

# Serial NOR Flash Cross Reference

DENS.	VCC	PACKAGES	ALLIANCE	MICRON	ADESTO	SPANSION	WINBOND	MACRONIX	ISSI	GIGA DEVICES
2Mb	3.3V	8pin SOIC (150mils)	M45PE20-VMN6P	M45PE20-VMN6	AT45DB021E					
8Mb	3.3V	8pin DFN (6x5mm)	M45PE80-VMP6G	M45PE80-VMP6	AT45DB081E					
8Mb	3.3V	8pin DFN (6x5mm)	M45PE80-VMP6TG	M45PE80-VMP6	AT45DB081E					
16Mb	3.3V	8pin SOIC (208mils)	M45PE16-VMW6TG	M45PE16-VMW6	AT45DB161E					
4Mb	3.3V	8pin SOIC (150mils)	AS25F34MD-10S11N	M25P40-AVMN6	AT25SF041	S25FL040	W25Q40	MX25L40 MX25V40	IS25LP040 IS25LQ040	GD25Q40 GD25B40 GD25D40
16Mb	3.3V	8pin SOIC (150mils)	AS25F316MQ-10S11N	M25P16-AVMN6 M25PX16	AT25SF161 AT25FF161	S25FL016	W25Q16	MX25L16 MX25V16	IS25LP016 IS25LQ016	GD25Q16 GD25B16
32Mb	3.3V	8pin DFN (4x3mm)	N25Q032A13EF440F	N25Q032A13EF4	AT25DF32/AT25SF32	S25FL032A/P	W25Q32	MX25L32	IS25LP032 / IS25LQ032	GD25Q32
32Mb	3.3V	8pin DFN (4x3mm)	N25Q032A13EF4A0F	N25Q032A13EF4	AT25DF32/AT25SF32	S25FL032A/P	W25Q32	MX25L32	IS25LP032 / IS25LQ032	GD25Q32
32Mb	3.3V	8pin DFN (6x5mm)	N25Q032A13EF640F	N25Q032A13EF6	AT25DF32/AT25SF32	S25FL032A/P	W25Q32	MX25L32	IS25LP032 / IS25LQ032	GD25Q32
32Mb	3.3V	8pin SOIC (150mils)	N25Q032A13ESC40G	N25Q032A13ESC	AT25DF32/AT25SF32	S25FL032A/P	W25Q32	MX25L32	IS25LP032 / IS25LQ032	GD25Q32
32Mb	3.3V	8pin SOIC (150mils)	N25Q032A13ESCA0F	N25Q032A13ESC	AT25DF32/AT25SF32	S25FL032A/P	W25Q32	MX25L32	IS25LP032 / IS25LQ032	GD25Q32
32Mb	3.3V	16pin SOIC (300mils)	N25Q032A13ESFA0F	N25Q032A13ESF	AT25DF32/AT25SF32	S25FL032A/P	W25Q32	MX25L32	IS25LP032 / IS25LQ032	GD25Q32
64Mb	1.8V	8pin SOIC (208mils)	N25Q064A11ESEA0F	N25Q064A11ESE	AT25SL64/AT25QL64		W25Q64	MX25U64	IS25WP064	GD25LQ64
64Mb	3.3V	8pin DFN (6x5mm)	N25Q064A13EF640E	N25Q064A13EF6	AT25SF64/AT25QF64	S25FL064A/P	W25Q64	MX25L64	IS25LP064	GD25Q64
64Mb	3.3V	8pin DFN (8x6mm)	N25Q064A13EF8A0E	N25Q064A13EF8	AT25SF64/AT25QF64	S25FL064A/P	W25Q64	MX25L64	IS25LP064	GD25Q64
64Mb	3.3V	8pin DFN (8x6mm)	N25Q064A13EF8A0F	N25Q064A13EF8	AT25SF64/AT25QF64	S25FL064A/P	W25Q64	MX25L64	IS25LP064	GD25Q64
64Mb	3.3V	8pin DFN (8x6mm)	N25Q064A13EF8H0E	N25Q064A13EF8	AT25SF64/AT25QF64	S25FL064A/P	W25Q64	MX25L64	IS25LP064	GD25Q64
64Mb	3.3V	16pin SOIC (300mils)	N25Q064A13ESFA0F	N25Q064A13ESF	AT25SF64/AT25QF64	S25FL064A/P	W25Q64	MX25L64	IS25LP064	GD25Q64
64Mb	3.3V	8pin SOIC (208mils)	AS25F364MQ-10SIN	N25Q064A13ESE	AT25QF64	S25FL064	W25Q64	MX25L64	IS25LP064	GD25Q64
64Mb	3.3V	8L WSON (6x5mm)	AS25F364MQ-10WIN	N25Q064A13EF6	AT25QF64	S25FL064	W25Q64	MX25L64	IS25L064	GD25Q64
128Mb	1.8V	8pin SOIC (208mils)	AS25F1128MQ-70SIN	MT25QU128ABA1ESE	AT25SL128A-SUE	S25FS128SDSMFI	W25Q128JWSIM	MX25U12832FM2I	IS25WP128-JBLE	GD25LB128ESIG
128Mb	1.8V	8L WSON (6x5mm)	AS25F1128MQ-70WIN	MT25QU128ABA1EW7	AT25SL128A-MHE	S25FS128SDSNFI	W25Q128JWPIM	MX25U12832FZNI	IS25WP128-JKLE	GD25LB128EWIG

# Serial SLC NAND Flash

DENSITY	BUS WIDTH	SPEED (NS)	VCC	PACKAGES	TEMPERTURE RANGE	TYPE	ALLIANCE
1Gb	x1, x2, x4	120 Mhz	3.3V	8pin LGA (8x6mm)	Industrial (-40°C to 85°C)	4bit ECC, (2048 + 64) bytes × 64 pages × 1024 blocks	AS5F31G04SND-08LIN
2Gb	x1, x2, x4	100 Mhz	1.8V	8pin LGA (8x6mm)	Industrial (-40°C to 85°C)	8bit ECC, (2048 + 128) bytes × 64 pages × 2048 blocks	AS5F12G04SND-10LIN
2Gb	x1, x2, x4	120 Mhz	3.3V	8pin LGA (8x6mm)	Industrial (-40°C to 85°C)	8bit ECC, (2048 + 128) bytes × 64 pages × 2048 blocks	AS5F32G04SNDA-08LIN
2Gb	x1, x2, x4	120 Mhz	3.3V	8pin LGA (8x6mm)	Industrial (-40°C to 85°C)	4bit ECC, (2048 + 128) bytes × 64 pages × 2048 blocks	AS5F32G04SNDB-08LIN
4Gb	x1, x2, x4	100 Mhz	1.8V	8pin LGA (8x6mm)	Industrial (-40°C to 85°C)	8bit ECC, (2048 + 128) bytes × 64 pages × 4096 blocks	AS5F14G04SND-10LIN
4Gb	x1, x2, x4	120 Mhz	3.3V	8pin LGA (8x6mm)	Industrial (-40°C to 85°C)	8bit ECC, (2048 + 128) bytes × 64 pages × 4096 blocks	AS5F34G04SNDA-08LIN
4Gb	x1, x2, x4	120 Mhz	3.3V	8pin LGA (8x6mm)	Industrial (-40°C to 85°C)	4bit ECC, (2048 + 128) bytes × 64 pages × 4096 blocks	AS5F34G04SNDB-08LIN
8Gb	x1, x2, x4	100 Mhz	1.8V	8pin LGA (8x6mm)	Industrial (-40°C to 85°C)	8bit ECC, (4096 + 256) bytes × 64 pages × 4096 blocks	AS5F18G04SND-10LIN
8Gb	x1, x2, x4	120 Mhz	3.3V	8pin LGA (8x6mm)	Industrial (-40°C to 85°C)	8bit ECC, (4096 + 256) bytes × 64 pages × 4096 blocks	AS5F38G04SND-08LIN

# Serial NAND Flash Cross Reference

DENS.	SPEED (NS)	VCC	ALLIANCE	MICRON	TOSHIBA/KIOXIA	WINBOND	MACRONIX	GIGA DEVICES	ISSI
1Gb	120Mhz	3V	AS5F31G04SND-08LIN	MT29F1G01ABAFDWB-IT	TC58CVG0S3HRAIJ	W25N01GV W25N01KV	MX35LF1GE4AB MX35LF1G24AD	GD5F1GQ4Ux GD5F1GQ5Ux GD5F1GM7Ux	IS37SML01G1-LLI IS37SML01G8A-JJLI
2Gb	100Mhz	1.8V	AS5F12G04SND-10LIN	MT29F2G01ABBGDWB-IT:G	TC58CYG1S3HRAIJ	W25N02JW W25M02GW	MX35UF2G14AC MX35UF2G24AD MX35UF2GE4AC MX35UF2GE4AD	GD5F2GQ4Rx GD5F2GQ5Rx GD5F2GM7Rx	IS37SMW02G8A-JJLI
2Gb	120Mhz	3V	AS5F32G04SNDA-08LIN AS5F32G04SNDB-08LIN	MT29F2G01ABAGDWB-IT	TC58CVG1S3HRAIJ	W25M02GV	MX35LF2G14AC MX35LF2GE4AD MX35LF2G24AD	GD5F2GQ4Ux GD5F2GQ5Ux GD5F2GM7Ux	IS37SML02G8A-JJLI
4Gb	100Mhz	1.8V	AS5F14G04SND-10LIN	MT29F4G01ABBFDWB-IT	TC58CYG2S0HRAIJ	W25N04KW	MX35UF4G24AD MX35UF4GE4AD	GD5F4GQ6Rx GD5F4GM8Rx	IS37SMW04G8A-JJLI
4Gb	120Mhz	3V	AS5F34G04SNDA-08LIN AS5F34G04SNDB-08LIN	MT29F4G01ABAFDWB	TC58CVG2S0HRAIJ	W25N04KV	MX35LF4G24AD MX35LF4GE4AD	GD5F4GQ6Ux GD5F4GM8Ux	IS37SML04G8A-JJLI
8Gb	100Mhz	1.8V	AS5F18G04SND-10LIN		TH58CYG3S0HRAIJ				IS37SMW08G8A-JJLI
8Gb	120Mhz	3V	AS5F38G04SND-08LIN		TH58CVG3S0HRAIJ				IS37SML08G8A-JJLI

# eMMC

DENSITY	VCC	VCCQ	BUS WIDTH	MMC INTERFACE	CLOCK FREQUENCY	PACKAGES	NAND TYPE	TEMPERATURE OPTIONS	ALLIANCE
4GB	2.7V~3.6V	1.8V / 3.3V	x1, x4, x8	v5.1	200 MHz	153b FBGA (11.5x13mm)	MLC	Industrial(-40°C to 85°C)	ASFC4G31M-51BIN
8GB	2.7V~3.6V	1.8V / 3.3V	x1, x4, x8	v5.1	200 MHz	153b FBGA (11.5x13mm)	MLC	Industrial(-40°C to 85°C)	ASFC8G31M-51BIN
16GB	2.7V~3.6V	1.8V / 3.3V	x1, x4, x8	v5.1	200 MHz	153b FBGA (11.5x13mm)	MLC	Industrial(-40°C to 85°C)	ASFC16G31M-51BIN
32GB	2.7V~3.6V	1.8V / 3.3V	x1, x4, x8	v5.1	200 MHz	153b FBGA (11.5x13mm)	TLC	Industrial(-40°C to 85°C)	ASFC32G31T3-51BIN
64GB	2.7V~3.6V	1.8V / 3.3V	x1, x4, x8	v5.1	200 MHz	153b FBGA (11.5x13mm)	TLC	Industrial(-40°C to 85°C)	ASFC64G31T5-51BIN
128GB	2.7V~3.6V	1.8V / 3.3V	x1, x4, x8	v5.1	200 MHz	153b FBGA (11.5x13mm)	TLC	Industrial(-40°C to 85°C)	ASFC128G32T5-51BIN

# eMMC Cross Reference

DENS.	PACKAGES.	TEMP GRADE	ALLIANCE	MICRON	SAMSUNG	KINGSTON	KIOXIA	ISSI	SANDISK	SK HYNIX	MACRONIX	SKY-HIGH
4GB	153ball FBGA (11.5x13mm)	Industrial Grade (-40°Cto 85°C)	ASFC4G31M-51BIN	MTFC4GACAJCN MTFC4GMWDM	KLM4G1GXXX	EMMC04GMK27 EMMC04GM627 EMMC04G-W627	THGBMNG5D1LBA	IS21ES04G-JCLI IS21ES04G-BCLI	X	H26M31001HPR	MX52LM04A11X	S40FC004C1B
8GB	153ball FBGA (11.5x13mm)	Industrial Grade (-40°Cto 85°C)	ASFC8G31M-51BIN	MTFC8GACAENS MTFC8GAKAJCN MTFC8GAMALBH MTFC8GAMALGT MTFC8GLWDM	KLM8G1GEUF KLM8G1GESD KLM8G1GETF	EMMC08GML36	THGBMJG6C1LBA	IS21ES08GA-JCLI IS21ES08GA-BCLI	SDINBDG4-8G	H26M41208HPR	MX52LM08A11X	S40FC008C3B
16GB	153ball FBGA (11.5x13mm)	Industrial Grade (-40°Cto 85°C)	ASFC16G31M-51BIN	MTFC16GAKAECN MTFC16GAKAEJP MTFC16GAPALBH	KLMAG1JETD KLMAG2GESD KLMAG2GEUF	EMMC16G-TB29 EMMC16G-IB29	THGBMUG7C1LBA THGAMVG7T13BA	IS21TF16G-JCLI IS21TF16G-BCLI	SDINBDA6-16G	H26M51002KPR	X	S40FC016C3B
32GB	153ball FBGA (11.5x13mm)	Industrial Grade (-40°Cto 85°C)	ASFC32G31T3-51BIN	MTFC32GAKAECN MTFC32GAKAEJP MTFC32GAZAQHD MTFC32GAPALBH	KLMBG2JETD KLMBG4GESD	EMMC32G-TX29 EMMC32G-IX29	THGBMUG8C2LBA THGAMVG8T13BA THGBMJG88C4LBA	IS21TF32G-JCLI IS21TF32G-BCLI	SDINBDA6-32G SDINBDG4-32G	H26M62002JPR H26M64208EM	X	X
64GB	153ball FBGA (11.5x13mm)	Industrial Grade (-40°Cto 85°C)	ASFC64G31T5-51BIN	MTFC64GAZAQHD MTFC64GAPALBH	KLMCG2KCTA KLMCG2UCTA KLMCG2UCTB KLMCG4JEUD KLMCG8GESD	EMMC64G-TY29 EMMC64G-IY29	THGAMVG9T23BA THGBMJG9C8LBA	IS21TF64G-JCLI IS21TF64G-BCLI	SDINBDA6-64G SDINBDG4-64G	H26M74002HMR H26M78208CMR	X	X
128GB	153ball FBGA (11.5x13mm)	Industrial Grade (-40°Cto 85°C)	ASFC128G32T5-51BIN	MTFC128GAPALNS MTFC128GAZAQJP	KLMDG4UCTA KLMDG4UCTB KLMDG8JEUD	EMMC128-TY29 EMMC128-IY29	THGAMVT0T43BA	IS21TF128G-JCLI IS21TF128G-BCLI	SDINBDA6-128G	X	X	X

# pSRAM PSEUDO SRAM

DENSITY	ORG	VCC	PACKAGE	TEMPERATURE	SPEED	ALLIANCE
8Mb	512K x 16	1.8V	48 FPBGA (6x7mm)	Industrial (-30°C ~+85°C)	70ns	AS1C512K16PL-70BIN
8Mb	512K x 16	3V	48 FPBGA (6x7mm)	Industrial (-40°C~ +85°C)	70ns	AS1C512K16P-70BIN
16Mb	1M x 16	1.8V	48 FPBGA (6x7mm)	Industrial (-40°C~ +85°C)	70ns	AS1C1M16PL-70BIN
16Mb	1M x 16	3V	48 FPBGA (6x7mm)	Industrial (-40°C~ +85°C)	70ns	AS1C1M16P-70BIN
32Mb	2M x 16	3V	48 FPBGA (6x7mm)	Industrial (-40°C~ +85°C)	70ns	AS1C2M16P-70BIN
64Mb	4M x 16	1.8V	49 FBGA (4x4mm)	Industrial (-30°C ~+85°C)	70ns	AS1C4M16PL-70BIN
128Mb (*2-stacked die)	8M x 16	1.8V	49 FBGA (4x4mm)	Industrial (-30°C ~+85°C)	70ns	AS1C8M16PL-70BIN

# pSRAM Cross Reference

ORG	DENSITY	PACKAGE	COMMENTS/ PREV REV	ALLIANCE	JSC/JEJU	ISSI	FIDELIX	AP MEMORY
8Mb	512K x 16	48 FPBGA	page mode & Non-DPD	AS1C512K16PL-70BIN	EM784SP16BPP-70LF	IS66WV51216EALL-70BLI		
8Mb	512K x 16	48 FPBGA	Non-page mode & Non-DPD	AS1C512K16P-70BIN	JS784SU16BSP-70LFI	IS66/67WV51216EBLL-70BL	FMP0817CAx	
16Mb	1M X16	48 FPBGA	Non-page mode & Non-DPD	AS1C1M16PL-70BIN	EM7164SP16CSP-70LFI	IS66W1M16EALL-70BLI	FMP1617CCx	
16Mb	1M X16	48 FPBGA	Non-page mode & Non-DPD	AS1C1M16P-70BIN	JS164SU16BSP-70LFI	IS66/67WV1M16EBLL-70BL	FMP1617CAx	
32Mb	2M X16	48 FPBGA	Non-page mode & Non-DPD	AS1C2M16P-70BIN	JS7324SU16BSP-70LFI	IS66WVE2M16EBLL-70B	FMP3217CAx	
64Mb	4M X16	49 FBGA	DPD mode	AS1C4M16PL-70BIN	EMC643SP16CKDT-70LF			
128Mb (*2-stacked die)	8M X16	49 FBGA	DPD mode	AS1C8M16PL-70BIN	JSC283SP16ATDT-70LF			APS128XX

# ALLIANCE PART NUMBERING SYSTEM - SRAM

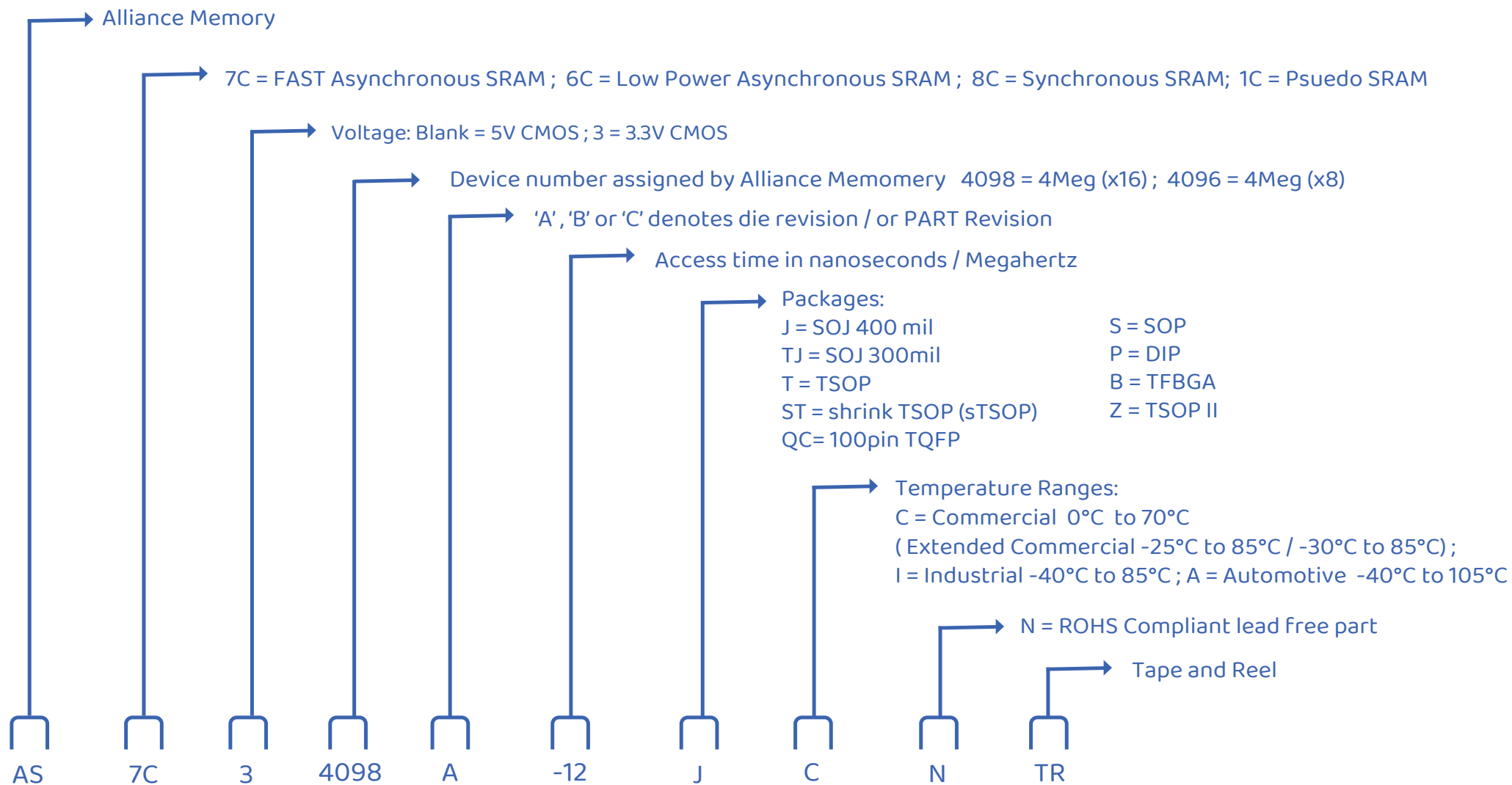



# ALLIANCE PART NUMBERING SYSTEM - DRAM

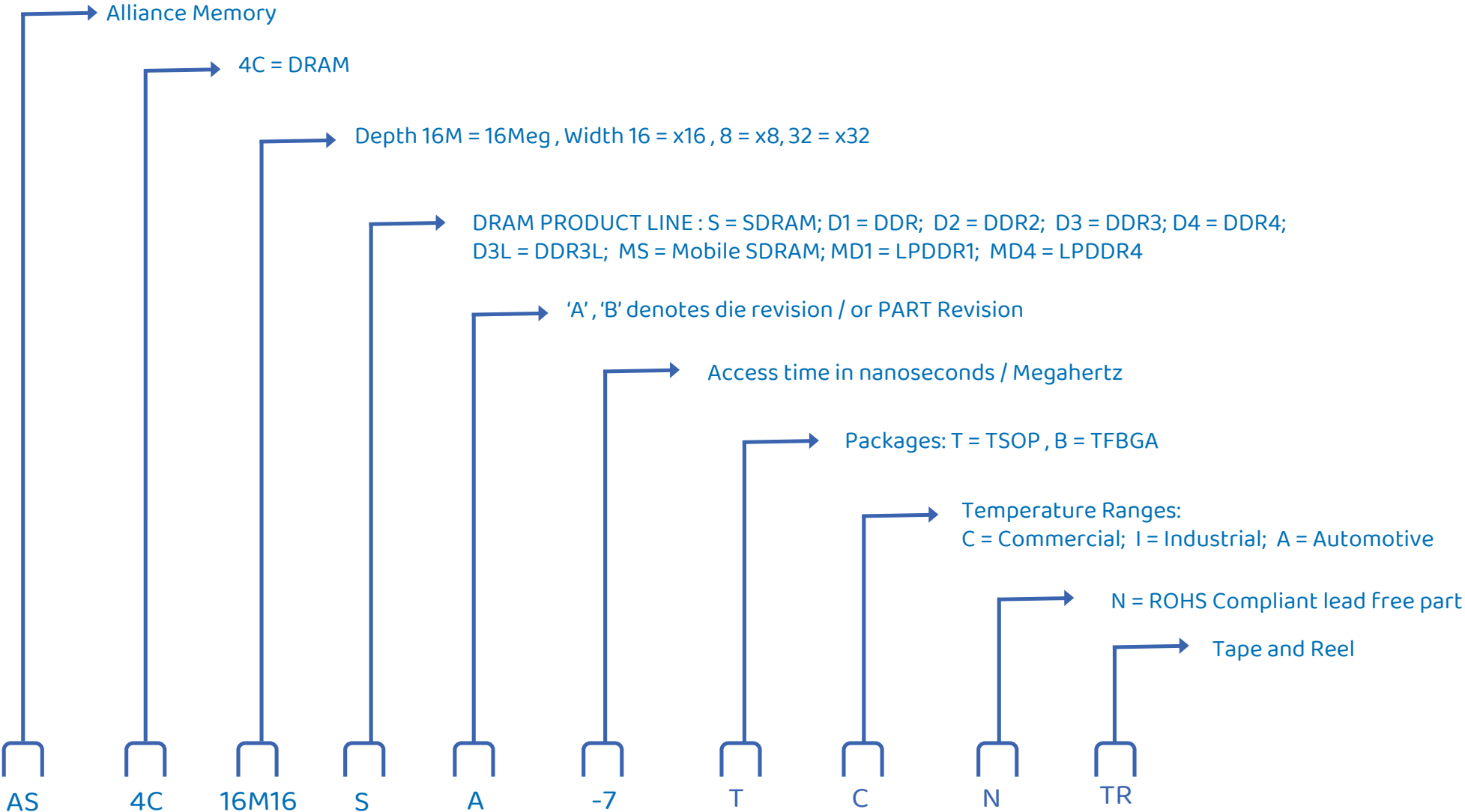

# ALLIANCE PART NUMBERING SYSTEM - LPDDR4/x

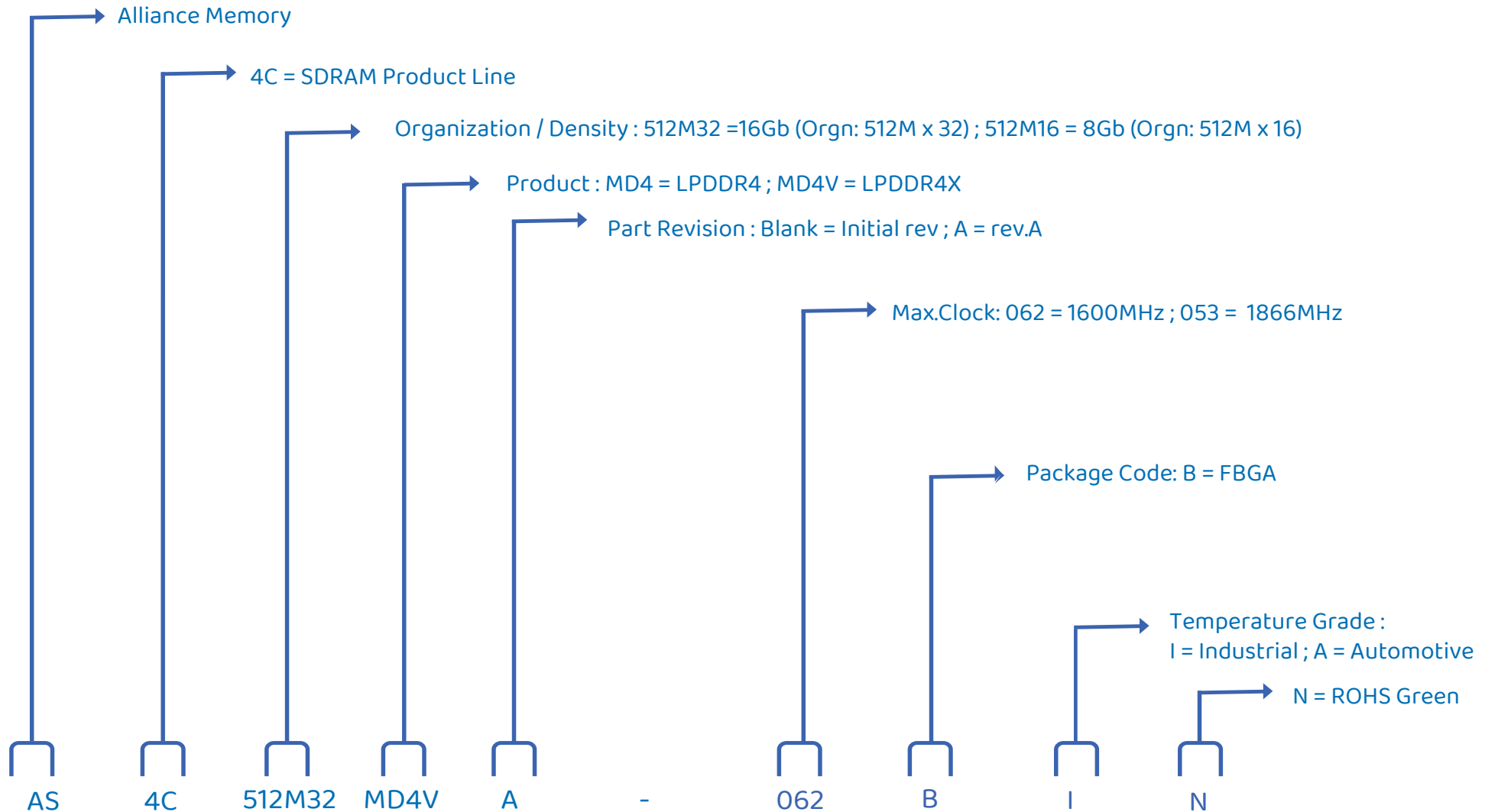

# ALLIANCE PART NUMBERING SYSTEM - SLC Parallel NAND Flash

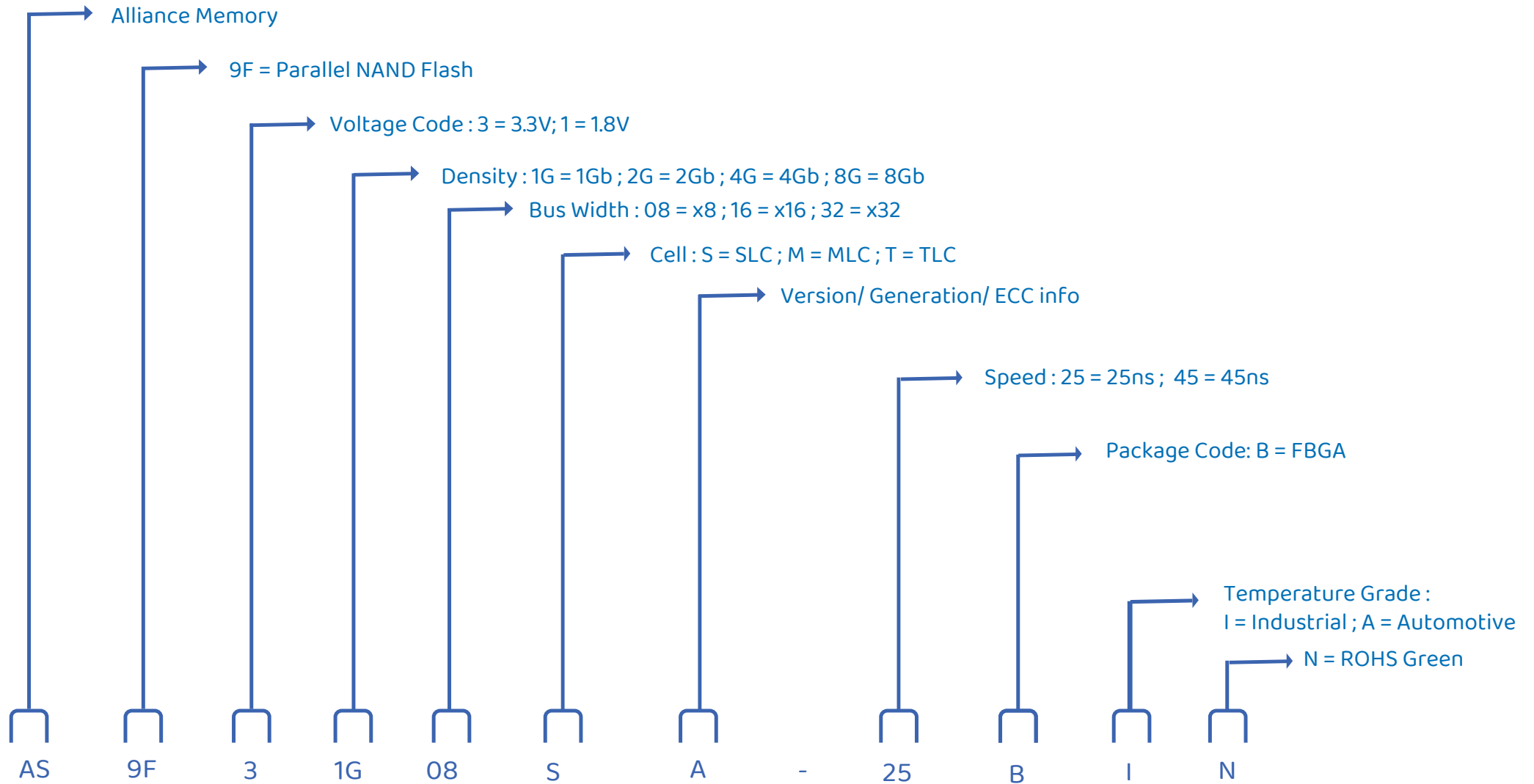

# ALLIANCE PART NUMBERING SYSTEM - Serial SLC NAND Flash

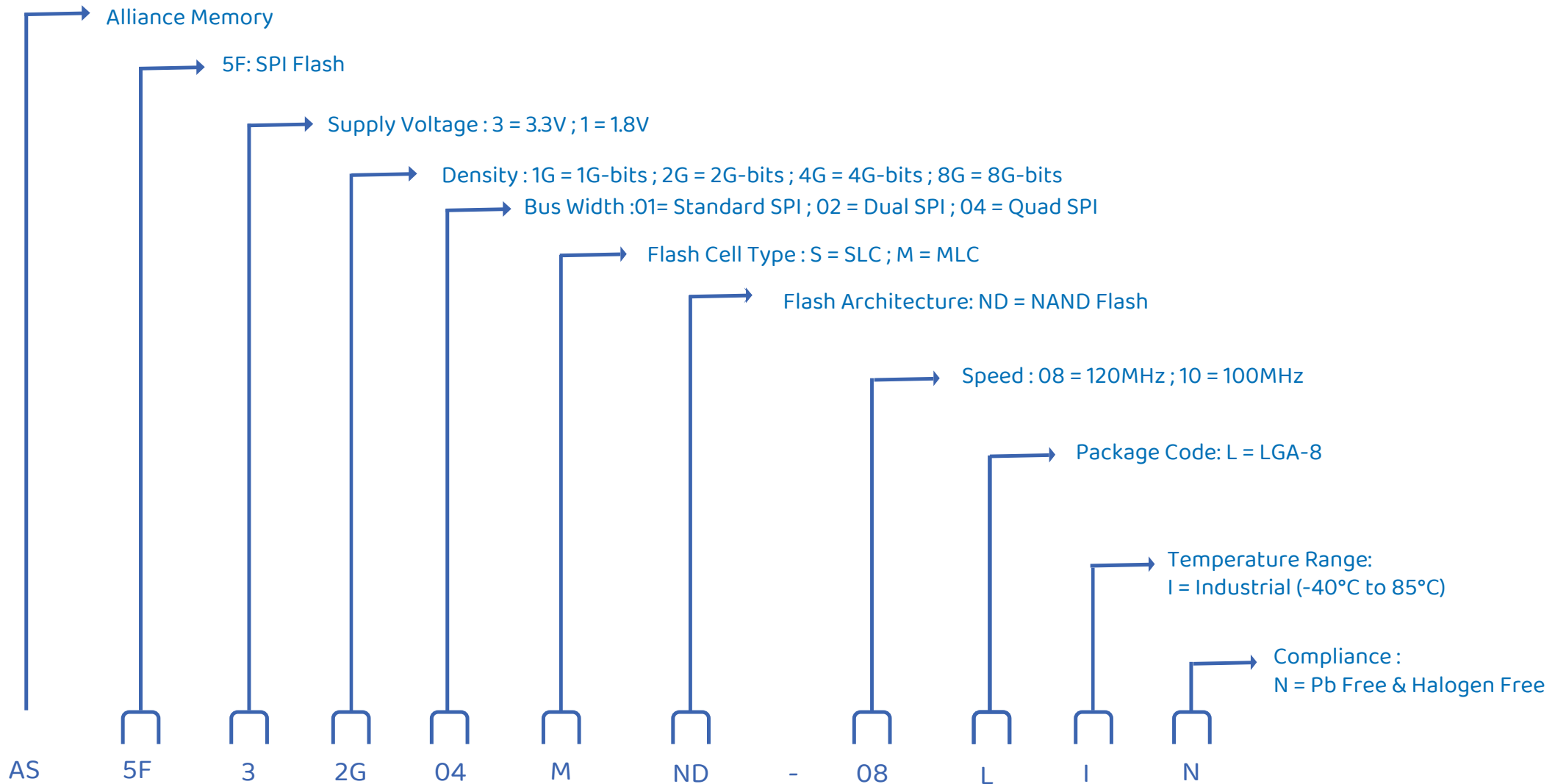

# ALLIANCE PART NUMBERING SYSTEM - eMMC

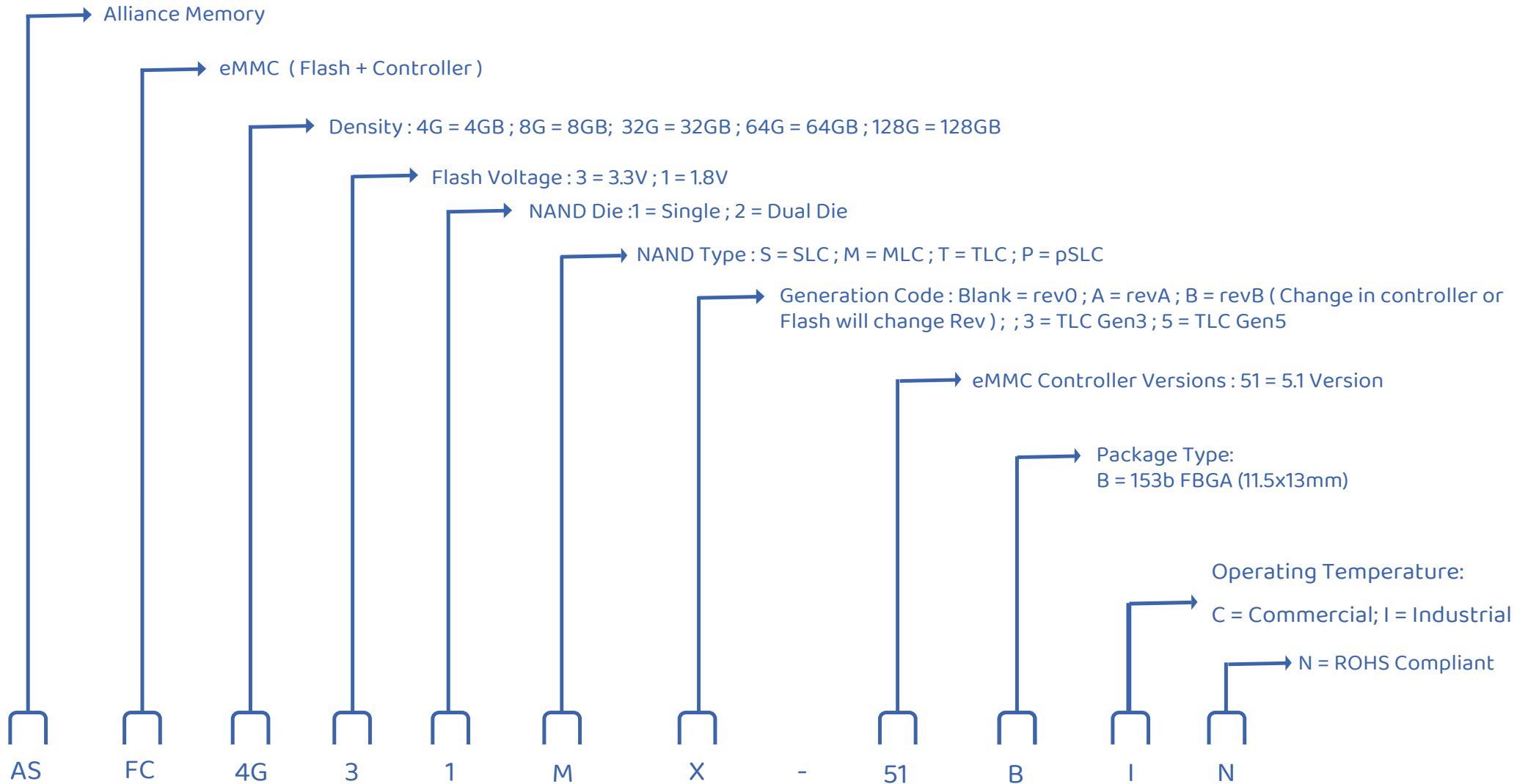

# ALLIANCE PACKAGING QUANTITIES

## FAST SRAM ORDER QTY

PART #	PACKAGE SUFFIX	PACKAGE	BOX QTY	QUANTITY PER TRAY/TUBE	REEL SIZE	TAPE WIDTH (mm)	TAPE PITCH (mm)
164A, 256A, 3256A	JxN	28 SOJ - 300mil	2500	25/Tube	1000	24	12
256B	JIN	28 SOJ - 300mil	1080	27/Tube	1000	24	12
3256B	JIN	28 SOJ - 300mil	1352	26/Tube	1000	24	12
256A, 3256A	TxN	28 TSOP I (8x13.4)	2340	234/Tray	1000	24	12
1025B, 31025B, 1024B, 31024B	TJCN	32.3 SOJ - 300mil	2200	22/Tube	1000	32	12
1024C	TJIN	32.3 SOJ - 300mil	920	23/Tube	1000	32	12
31025C	TJIN	32.3 SOJ - 300mil	805	23/Tube	1000	32	12
1025B, 31025B, 1024B, 31024B	JCN	32.4 SOJ - 400mil	2100	21/Tube	1000	32	16
1024C, 1025C, 31025C	JIN	32.4 SOJ - 400mil	805	23/Tube	1000	32	16
513B, 3513B, 1026B, 31026B	JCN	44 SOJ - 400mil - 1 Meg	1600	16/Tube	500	44	16
1026C, 31026C	JIN	44 SOJ - 400mil - 1 Meg	560	16/Tube	500	44	16
1024B, 31024B	TCN	32 TSOP I (8x20)	1560	156/Tray	1000	32	12
31025C	TIN	32 TSOP I (8x20)	805	23/Tube	1000	32	12
513B, 3513B, 1026B, 31026B	TCN	44 TSOP II - 400mil - 1 Meg	1350	135/Tray	1000	32	16
1026C, 31026C	TIN	44 TSOP II - 400mil - 1 Meg	1352	26/Tube	1500	32	16
31026C	BIN	48ball FBGA	3600	360/Tray	2000	44	16
4096A, 34096A, 4098A, 34098A	TxN	44 TSOP II - 400mil - 4 Meg	1350	135/Tray	1000	32	16
4096A, 34096A	JxN	36 SOJ - 400mil	1900	19/Tube	500	44	16
4098A, 34098A	JxN	44 SOJ - 400mil - 4 Meg	1600	16/Tube	500	44	16
34098A	B	48ball BGA	2200	480/Tray			
38096A, 38098A	TIN	44 TSOP II	1350	135/Tray	1000	44	16
38096A, 38098A	B	48ball BGA	4800	480/Tray	2000	44	16
316096A, 316098A	TIN	48 TSOP I	960	96/Tray	1500	44	16
316098A	B	48ball BGA	4800	480/Tray	2000	16	16
325632, 351232	BIN	90ball TFBGA	2400	240/Tray	2000		

# ALLIANCE PACKAGING QUANTITIES

## LOW POWER SRAM ORDER QTY

PART #	PACKAGE SUFFIX	PACKAGE	BOX QTY	QUANTITY PER TRAY/TUBE	REEL SIZE	TAPE WIDTH (mm)	TAPE PITCH (mm)
6264/62256	S	28pin 330mil SOP	2500	25/Tube	1000	24	16
6264/62256	P	28pin 600mil DIP	600	15/Tube			
6264/62256	ST	28pin STSOP (8x13.4)	2340	234/Tray	1500	24	12
1008/2008/4008	P	32pin 600mil DIP	520	13/Tube			
1008/2008/4008	S	32pin 450mil SOP	720	72/Tray	1000	32	16
1008/2008/4008	T	32pin TSOP I (8x20)	1560	156/Tray	1500	32	12
1008/2008/4008	ST	32pin STSOP (8x13.4)	2340	234/Tray	1500	24	12
1016/2016/4016/8008/8016	Z	44pin TSOP II 400mil	1350	135/Tray	1000	32	12
1616/6416	T	48pin TSOP I	960	96/Tray	1500		
1008/2008/4008/8008/1016/ 1616/2016/4016/8016/1616/3216	B	36B/48B TFBGA (6x8)	4800 or 3000	480/Tray Or 300/Tray	2000	16	12
4008	Z	32pin TSOP II	1170	117/Tray	1000	32	16



# ALLIANCE PACKAGING QUANTITIES

## DRAM ORDER QTY

PART#	PACKAGE	BOX QTY	QUANTITY PER TRAY/REEL	REEL SIZE
SDRAM				
AS4C1M16S	50pin TSOP II	1170	117/Tray	1000
AS4C16M16SA-6TAN/AS4C16M16SA-6TCN/AS4C16M16SA-6TIN/ AS4C16M16SA-7TCN/AS4C16M16SB-6TIN/AS4C16M16SB-7TCN/ AS4C32M16SB-6TIN/AS4C32M16SB-7TCN/AS4C32M16SB-7TIN/ AS4C32M16SC-7TIN/AS4C32M8SA-6TIN/AS4C32M8SA-7TCN/ AS4C4M16SA-5TCN/AS4C4M16SA-6TAN/AS4C4M16SA-6TCN/ AS4C4M16SA-6TIN/AS4C4M16SA-7TCN/AS4C4M16SB-6TIN/ AS4C64M4SA-6TIN/AS4C64M4SA-7TCN/AS4C64M8SC-7TIN/ AS4C8M16SA-6TAN/AS4C8M16SA-6TCN/AS4C8M16SA-6TIN/ AS4C8M16SA-7TCN/AS4C8M16SB-6TIN/	54pin TSOP II	1080	108/Tray	1000
AS4C64M8SD-7TCN	54pin TSOP II	1080	108/Tray	1500
AS4C16M16SA-6BAN/AS4C16M16SA-6BIN/AS4C16M16SA-7BCN/ AS4C16M16SB-6BIN/AS4C32M16SB-7BIN/AS4C4M16SA-6BAN/ AS4C4M16SA-6BIN/AS4C4M16SA-7BCN/AS4C8M16SA-6BAN/ AS4C8M16SA-6BIN/AS4C8M16SA-7BCN	54ball BGA	3480	348/Tray	2500
AS4C4M16SA-7B2CN	60ball FBGA	2860	286/Tray	2000
AS4C4M32SA/AS4C8M32S/AS4C8M32S	86pin TSOP II	1080	108/Tray	1000
AS4C4M32S/AS4C8M32SA	90ball BGA	1900	190/Tray	2000

# ALLIANCE PACKAGING QUANTITIES

## DRAM ORDER QTY

PART#	PACKAGE	BOX QTY	QUANTITY PER TRAY/REEL	REEL SIZE
<b>DDR1</b>				
AS4C32M16D1A/AS4C4M16D1A/AS4C64M16D1/AS4C64M16D1A/AS4C64M16D1/AS4C64M16D1A/ AS4C64M8D1/AS4C8M16D1A	66pin TSOP II	1080	108/Tray	1000
AS4C64M16D1A	60ball FBGA	2400	240/Tray	1000
AS4C64M8D1/AS4C8M16D1	60ball TFBGA	2400	240/Tray	2500
AS4C4M32D1A	144ball FBGA	1890	189/Tray	1500
<b>DDR2</b>				
AS4C128M16D2A /AS4C16M16D2 / AS4C32M16D2A/AS4C32M16D2C/AS4C64M16D2A	84ball FBGA	2090	209/Tray	2500
AS4C64M8D2	60ball FBGA	2640	264/Tray	2000
AS4C64M16D2B	84ball FBGA	2000	200/Tray	2500
AS4C128M16D2	84ball FBGA	1620	162/Tray	2500
AS4C256M8D2	60ball FBGA	1360	136/Tray	2500
<b>DDR3</b>				
AS4C32M16D3-12BxN/AS4C32M16D3L-12BxN	96ball FBGA	1900	190/Tray	1500
AS4C64M16D3B	96ball FBGA	1900	190/Tray	2000
AS4C64M16D3LB	96ball FBGA	1900	190/Tray	2000
AS4C128M16D3C	96ball FBGA	2090	209/Tray	2500
AS4C256M16D3C	96ball FBGA	2090	209/Tray	2000
AS4C256M16D3LC	96ball FBGA	2090	209/Tray	2500
AS4C512M16D3LA/AS4C512M16D3LB	96ball FBGA	1800	180/Tray	2000
AS4C512M16D3LC	96ball FBGA	1900	190/Tray	2000

# ALLIANCE PACKAGING QUANTITIES

## DRAM ORDER QTY

PART#	PACKAGE	BOX QTY	QUANTITY PER TRAY/REEL	REEL SIZE
<b>MOBILE SDRAM</b>				
AS4C16M16MSA/AS4C8M16MSA/AS4C16M16MSB/AS4C8M16MSB	54-ball FBGA	3190	319/Tray	1000
AS4C32M16MSA/AS4C32M16MSB	54-ball BGA	3190	319/Tray	1000
AS4C4M32MSA/AS4C8M32MSA/AS4C8M32MSB	90-ball FBGA	1900 /2400	190/240 Tray	1000/2000
AS4C16M32MSA/AS4C16M32MSB	90-ball BGA	1900	190/Tray	1500
<b>MOBILE LPDDR1</b>				
AS4C32M16MD1A	60-ball FPBGA	1600	160/Tray	2000
AS4C64M16MD1A	60-ball FPBGA	3000	300/Tray	1000
AS4C16M32MD1	90-ball FPBGA	1600	160/Tray	1000
AS4C32M32MD1A	90-ball FPBGA	2400	240/Tray	1000
AS4C64M32MD1	90-ball FPBGA	3480	348/Tray	1000
<b>MOBILE LPDDR2</b>				
AS4C32M32MD2A-25BIN/AS4C64M16MD2A-25BIN	134ball FBGA (10 x 11.5 x 1.0)	1280	128/Tray	2000
AS4C128M16MD2A-25BIN/AS4C64M32MD2A-25BIN/AS4C8M32MD2A-25BCN	134ball FBGA (10 x 11.5 x 1.0)	1710	171/Tray	1000
AS4C128M32MD2-18/25BIN	134ball FBGA (11.5 x 11.5 x 1.0)	1680	168/Tray	2000
AS4C8M32MD2A-25BPCN	168ball FBGA (12 x 12 x 0.9)	1680	168/Tray	Do Not Offer

# CONTACT INFORMATION



## US HEADQUARTERS

Alliance Memory, Inc.  
12815 NE 124th St, Suite #D, Kirkland,  
WA 98034  
- Phone: +1(425) 898 4456  
- Fax: +1(425) 896 8628  
- Email: david@alliancememory.com

## CANADA SALES OFFICE

Tom Gargan  
- Phone: +1(514) 442-0677  
- Email: tom@alliancememory.com

## NORTH AMERICA REP

Electra Sales Corporation  
21 Goodway Drive  
Rochester, NY 14623  
-Phone: +1 (585) 217-6496

## ASIA HEADQUARTERS

Alliance Memory, Inc.  
NO.22, Xingde Road, Dayuan DIST,  
Taoyuan City 337002, Taiwan  
- Phone: +886 3461 4646  
- Email: kelly@alliancememory.com

## CHINA SALES OFFICE

Room1108, 4# Building Excellence Century  
Center, Fuhua 3 Road, Futian District 518000  
Shenzhen, Guangdong, China  
- Phone: +86(189) 2600 6867  
- Email: mars@alliancememory.com

## JAPAN SALES OFFICE

3-7-10, Sakurajyousui, Setagaya-Ku,  
Tokyo, Japan 156-0045  
- Phone: +81(90) 3963 0869  
- Email: ted@alliancememory.com

## EMEA HEADQUARTERS

Alliance Memory, Inc.  
7 Pauls Field Eversley, Hampshire,  
RG27, ONE, United Kingdom  
- Phone: +44(0) 787-634-4055  
- Email: sue@alliancememory.com

## INDIA SALES OFFICE

Bangalore – INDIA  
Ramesh Varadharajan  
- Phone: +91 96065 00288  
- Email: ram@alliancememory.com

## KOREA SALES OFFICE

Linus Park  
- Email: linus@alliancememory.com



For a complete list of our distributors and REP  
Partners by country and region, please refer to  
our website : [www.alliancememory.com](http://www.alliancememory.com)

